

Visions of life 2009/10



See more. Experience more.

The Eschenbach consumer optics range offers the right product for every application – from a matchbox-sized monocular to high-performance all-weather pocket binoculars and twilight binoculars. Opto-electronic light intensifiers provide a new viewing experience which was previously not available from conventional binoculars.





Eschenbach: Tradition and progress

Almost 95 years of experience, the combination of tradition and the modern world, the orientation towards innovation and progress and the concentration on reliability and optimum performance – these criteria for success have made Eschenbach Optik one of the leading suppliers of optical products. In Germany and throughout the whole world.

The products range from spectacle frames and sunglasses, magnifying glasses and special vision aids to binoculars and many other products for leisure and outdoor activities.

With subsidiaries in Austria, Switzerland, France, Italy, Spain, Holland, Denmark, the Czech Republic and Poland, more than 30 trading partners throughout the world and marketing and sales organisations in the USA and Japan, Eschenbach Optik has a global presence.

Consistent investment in technology and know-how have promoted progress and brought Eschenbach international recognition. The company remains true to this philosophy and is visibly committed to it.

regatta®	6
club® W	8
farlux®	10
trophy®/sektor	14
adventure	20
Observation instruments	23
arena®	24
vektor	26
viva/magno®	27
Monoculars	28
Night-vision equipment/ Accessories	30
Opera- and theater glasses	32
Technical Specifications	34

To be closer to the action.

For sports events and nature watches, on holiday or at the theatre. Eschenbach's familiar combination of "quality – value for money – service" guarantees "far-sighted pleasure".

Numerous design awards prove that Eschenbach binoculars have plenty to offer on the style front, too.

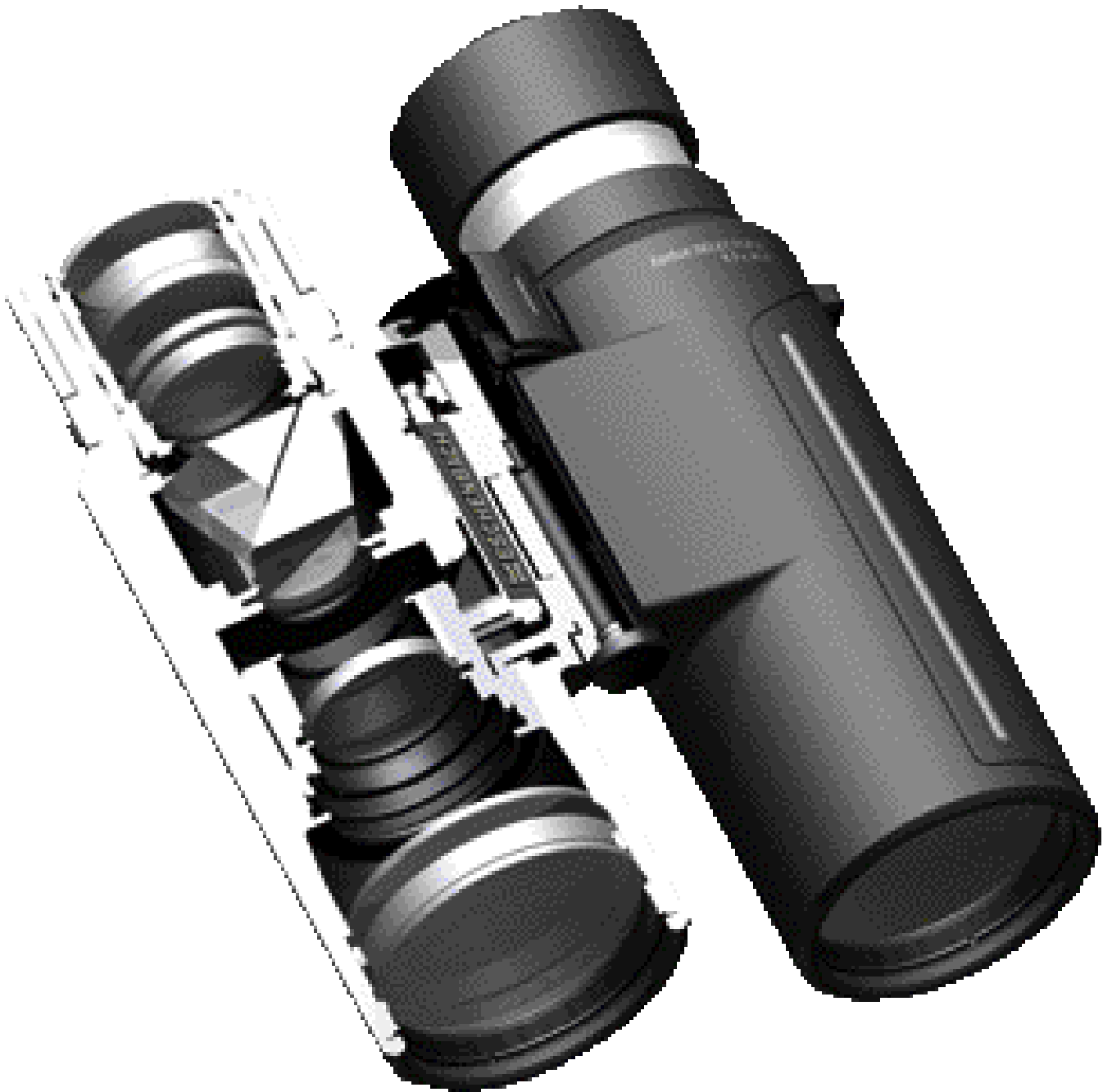



Porro prisms

The “classical” prisms: binoculars with Porro prisms are, as a rule, wider than comparable roof prism binoculars, but not as long. Owing to the fact that the lenses are further apart, conventional Porro prism binoculars offer a slightly more 3D image at short distances.



Roof prisms

are very compact and thus lead to particularly slim binoculars. A higher level of precision engineering is required for roof prism binoculars than for Porro prism binoculars of the same quality level.

Bk-7 prisms

Boron crown glass prisms, the standard for a quality image.

BaK-4 prisms

Selected and carefully machined high-performance prisms of barium crown glass provide even better resolution of details and a brighter image with high colour fidelity.

SK15 prisms

Prisms manufactured from extremely high quality SK15 glass. These prisms allow the minimization of undesired internal reflections and therefore provide a pin sharp image with optimum contrasts.



Magnification

This value gives the apparent magnification of a lens. 8 x magnification means that an object at a distance of 800 m appears to be at a distance of 100 m.

Lens

The lens diameter is given in mm. An important performance criterion for binoculars. The bigger it is, the more light it gathers and the brighter the field of view.



Exit pupil/brightness index/twilight factor

These are index values which result from the ratio of magnification and lens diameter. The following is important for real life: an exit pupil between 2 and 3 mm is sufficient for use in daylight. Binoculars with an exit pupil of 5-7 mm should be chosen for difficult light conditions.



Field of view

This value specifies the width of the terrain that you can see through the binoculars at a distance of 1000 m.

The greater the field of view, the easier it is to view landscapes or moving objects, for example at sports events or during animal observation. Binoculars marked Ww (=wide angle) have a particularly large field of view.



Minimum focus

This number gives the shortest distance at which objects can be seen sharply and without distortion. This is important to know for use in museums, during tourist excursions or similar events.



Phase correction

A particularly difficult surface treatment for prisms with special coatings. The ultimate for excellent image quality.



Internal focussing

Focussing means adjusting the “sharpness” of an image. Only the lenses inside the binoculars are moved during internal focussing. This means a closed system which avoids sucking in of dust, air or humidity.



All-weather/waterproof

Due to a system of water repellent features on the casing and the moveable components the binoculars are resistant to pressurized water.

Nitrogen filled

Eschenbach binoculars for heavy-duty all-weather applications are filled with nitrogen (N₂). This prevents misting up of the internal optical components in case of temperature changes.



Anti-reflection coating

Eschenbach binoculars are provided with fully coated optics. This means that all air/lens interfaces are provided with an extremely thin anti-reflection coating to optimise the “light movement” through the binoculars to the eye. Coatings with magnesium fluoride are obviously standard; these are also known as blue coating. On some binoculars, this is combined with multi-coating on one side of the lens and the eyepiece to provide a “combi coating” for even better light transmission. For the highest vision requirements multi-coating is always used on all lens faces.



With the Eschenbach “naturebright” coating, farlux and regatta binoculars ensure true-to-life, completely colour-accurate images.



Individual.
Stylish.
Different.
regatta[®]
8x42 B



regatta® 8 x 42 B

A perfect combination of design and functionality.

The regatta® is an exclusive pair of binoculars for all leisure activities, which emphasises your individual style with exceptional features. Whether sailing the ocean blue, going stalking, observing flora and fauna, or participating in any other outdoor activities – the regatta® 8x42 B boasts a range of outstanding features for any situation.

- Optimum colour fidelity and light transmission with "naturebright" coating and phase corrected prisms.
- The nitrogen-filled waterproof construction makes them durable enough to stand up to the harshest elements.
- Sturdy but light thanks to the impact-proof magnesium housing.
- Always ready to hand and protected by the waterproof and ergonomically shaped neoprene case.



regatta® 8 x 42 B

Ref. No:	4250842
Magnification	8 x
Lens Ø	42 mm
Field of view	113 m/1000 m
Accessories	One-piece protective eyepiece cap, padded carrying strap, neoprene case and tripod adapter for use with all standard tripods.
Guarantee	10 years

For more technical data please see p. 34/35

club *W*



•club® W

For special moments: Binoculars in a must-have look!

Whether teeing off on the golf course, going for a stroll at the marina or watching their favourite athlete – the club® W gives women with sophisticated tastes the opportunity to demonstrate their stylish outlook wherever they are. It isn't just the shimmering pearly white finish and sophisticated elegance that make the club® W so desirable, but its "inner qualities":

With 8x magnification, phase corrected BaK-7 and BaK-4 prisms with full multi-layer coatings, the little white beauties are perfect for surveying the scene whenever the mood strikes.

Nitrogen-filled and waterproof, they can be used at any time, in any place. The club® W doesn't just put the focus on your subject – it also focuses attention on itself – making it not just a practical accessory, but an attractive companion.

And the mother-of-pearl binoculars are a sure-fire winner for men too: a high-quality gift idea that'll be a welcome accessory for any woman and is something that little bit different.

club® W 8 x 25 B

Ref. No:	4265825
Magnification	8 x
Lens Ø	25 mm
Field of view	96 m/1000 m
Accessories	Stylish carrying case, padded strap and case for protection in your handbag.
Guarantee	5 years

For more technical data please see p. 34/35



farlux®



farlux® binoculars are a popular choice because of their exceptional optical performance, excellent workmanship and practical, attractive design. This makes binoculars from the farlux® range the first choice for ornithologists, huntsmen and anybody looking for first-class performance.

farlux® SELECTOR D

The eagle eye by Eschenbach

The best that Eschenbach currently has to offer. It's only with binoculars like these, which offer such bright, true-to-life and precise images that you'll be able to enjoy bird watching and nature observation to the full. Let the adventure begin!

- The magnesium housing means that the farlux® SELECTOR D is impact-resistant and, above all, lightweight.
- The special "naturebright" coating delivers precisely what the name says: an exceptional true-to-life, colour-accurate and bright image.
- The BaK-4 prisms are phase corrected for the ultimate viewing experience and have a high reflective coating.
- Equipped to cope with all types of weather: Water pressure proof (5 min at 1 m water depth) and filled with N₂.
- Threaded for tripod adapter.

The farlux® SELECTOR D is of course also ideal for hunting.



Case with integrated show card for effective and informative presentation in-store.



 naturebright

farlux® SELECTOR D 8.5 x 45 B

Ref. No:	4274845
Magnification	8.5 x
Lens Ø	45 mm
Field of view	117 m/1000 m
Accessories	Protective caps for eyepieces and lens, carrying strap, high quality bag and attractive wooden storage case for safe storage.
Guarantee	10 years

For more technical data please see p. 34/35



farlux® SELECTOR V

**Sheer pleasure for the eyes
Imagine a pair of binoculars which not only features
roof prisms and a zoom facility but is also waterproof!**

With fantastic optical quality and brilliant realistic colour reproduction, farlux® SELECTOR V binoculars are particularly suitable for bird-watching and hunting.

- With SK15 and BaK-4 phase corrected, high reflection prisms. The high reflection coating on the prisms produces an image which is approx. 8% brighter.
- As a result of the "naturebright" coating the light transmission in the spectral range is optimized by green light. This makes the image even more true-to-life and even more comfortable to the eye.
- The farlux® SELECTOR V is waterproof and can therefore be used even in damp conditions.
- Even at 15-times magnification the brightness of the image remains consistent and free from "tunnel vision".
- The user's personal dioptre adjustment on the centre adjustment wheel can be securely locked to prevent movement.
- The ergonomic grip on the front side of the binoculars means that the farlux® SELECTOR V can be held firmly and securely, even during prolonged use.
- Also includes screw thread for tripod adapter.

Case with integrated show card for effective and informative presentation in-store.



farlux® SELECTOR V 8-15 x 35 B

Ref. No:	42741
Magnification	8-15 x
Lens Ø	35 mm
Field of view	91-70 m/1000 m
Accessories	Protective eyepiece and lens caps, carrying strap, high quality carrying case and aluminium case with shoulder strap.
Guarantee	10 years



farlux® F-B silver

Experience maximum image brightness and colour reproduction with the new "naturebright" coating on farlux® binoculars.

We have again been able to increase light transmission up to 93 %. With "naturebright", you can enjoy optimum colour reproduction with farlux® F silver binoculars too. This is made possible by the 64 layers of coating on the prisms.

The well-known benefits of the farlux® F remain the same:

- No water marks on the lenses and
- Simple cleaning of them due to the "anti raindrop" coating.
- Robust even in wind and weather as filled with N₂ and water-proof.
- Can be used with (sun)glasses due to retractable eye pieces. Individual adjustment for spectacle wearers with 2 step extension and retraction of eyepieces.
- Safe transport of binoculars and padded carry strap -> both comfortably fit the bag.

In gift and presentation box.



Internationaler Designpreis
Baden-Württemberg 2004



 naturebright



farlux® F-B silver 8 x 24 B

Ref. No:	42848241
Magnification	8 x
Lens Ø	24 mm
Field of view	109 m/1000 m
Accessories	Belt bag, lens caps and comfortable carrying strap with neck padding.
Guarantee	10 years

farlux® F-B silver 10 x 28 B

Ref. No:	42841281
Magnification	10 x
Lens Ø	28 mm
Field of view	86 m/1000 m
Accessories	Belt bag, lens caps and comfortable carrying strap with neck padding.
Guarantee	10 years

For more technical data please see p. 34/35

trophy[®]/sektor



There are constantly new events and phenomena to be observed in nature.

That's why trophy® and sektor offer a wide choice of resilient and robust binoculars.

trophy® D-B allwetter

High-performance binoculars with eyepieces for spectacle wearers.

The trophy® roof prism binoculars with their comparatively small and light "sub-compact" design provide an excellent price/performance ratio through their technical features and elegant design.

- Particularly suited for short distance nature observation due to its very small minimum focus (2 m at 8 x 32; 2.5 m at 7 x 42 and 3 m at 10 x 50).
- Can be used in all weather as pressure-water-tight (3 minutes at 1 m depth).
- The trophy® AS/D is comfortably and safely in the hand, even during prolonged use, due to its shaped thumb recesses.
- Easy operation, even with gloves, due to large and tactile central focussing.
- Nitrogen filling prevents misting up of internal optical components due to temperature changes.
- Precise dioptre adjustment by stepped adjustment.
- Bright, sharp image in true colours due to full multi-coating and BaK-4 prisms.
- Full field of vision, also for wearers of (sun)glasses due to specially designed eyepieces with retractable cups.
- Threaded for a tripod adapter.

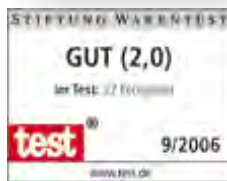

trophy® D 8 x 32 B

Ref. No:	4282832
Magnification	8 x
Lens Ø	32 mm
Field of view	131 m/1000 m
Accessories	Carry strap, lens caps and high-quality case.
Guarantee	10 years



trophy® D 7 x 42 B

Ref. No:	4282742
Magnification	7 x
Lens Ø	42 mm
Field of view	114 m/1000 m
Accessories	Carry strap, lens caps and high-quality case.
Guarantee	10 years



trophy® D 10 x 50 B

Ref. No:	4282150
Magnification	10 x
Lens Ø	50 mm
Field of view	88 m/1000 m
Accessories	Carry strap, lens caps and high-quality case.
Guarantee	10 years

For more technical data please see p. 34/35



trophy® P-B *allwetter*

Finally wide-angle optics for spectacle wearers, too!
Now watertight and nitrogen-filled.

- The trophy® P 8 x 40 and 10 x 50 B Ww combine for the first time special eyepieces for spectacle wearers with a wide-angle field of view.
- The 8 x 56 hunting binoculars are also equipped with eyepieces with retractable cups for spectacle wearers.
- Ideal for animal and nature observation in all weather as they are impermeable to water under pressure (5 minutes at 1 m depth).
- Nitrogen filling prevents misting up of internal optical components due to temperature changes.
- The trophy® P is comfortably and safely in the hand, even during prolonged use, due to its shaped thumb recesses.
- Easy operation, even with gloves, due to tactile central focussing and dioptre adjustment.
- Bright, sharp image in true colours due to full multi-coating and BaK-4 prisms.
- Threaded for a tripod adapter.



trophy® P 8 x 40 B Ww

Ref. No:	4237840
Magnification	8 x
Lens Ø	40 mm
Field of view	143 m/1000 m
Accessories	Carry strap, lens caps and high-quality case.
Guarantee	10 years

trophy® P 10 x 50 B Ww

Ref. No:	4237150
Magnification	10 x
Lens Ø	50 mm
Field of view	114 m/1000 m
Accessories	Carry strap, lens caps and high-quality case.
Guarantee	10 years

trophy® P 8 x 56 B

Ref. No:	4237856
Magnification	8 x
Lens Ø	56 mm
Field of view	102 m/1000 m
Accessories	Carry strap, lens caps and high-quality case.
Guarantee	10 years

For more technical data please see p. 34/35



trophy[®] F-B *allwetter*

Eyepieces for spectacle wearers and internal focusing.

With the trophy[®] folding binoculars range, the entire trophy[®] series is now waterproof and filled with nitrogen – therefore ideal for all kinds of weather.

- Clear image in true colours due to full multi-coating and BaK-4 prisms.
- Full field of vision even for those who wear (sun) glasses – equipped with special eyepieces for spectacle wearers with retractable cups.
- Sturdy rubber casing in trophy[®] style ensures non-slip grip and protects against knocks and dropping.



trophy[®] F 8 x 25 B

Ref. No:	42878252
Magnification	8 x
Lens Ø	25 mm
Field of view	91 m/1000 m
Accessories	Carry strap, protective caps and belt case.
Guarantee	10 years



trophy[®] F 10 x 25 B

Ref. No:	42871252
Magnification	10 x
Lens Ø	25 mm
Field of view	88 m/1000 m
Accessories	Carry strap, protective caps and belt case.
Guarantee	10 years

For more technical data please see p. 34/35

sektor F-Ww

Beautiful, small, convenient.

Featuring a practical rubber housing, Sektor F-Ww binoculars don't just look good, but are also comfortable to hold. Built to withstand a physical impact, they fold up to fit comfortably into a rucksack.

- Large field of view due to wide-angle optics, particularly suited to the observation of moving events, e.g. sports.
- Clear image due to combi coating and BaK-4 prisms.
- Protected from the ingress of dirt and moisture with small and compact dimensions due to sophisticated internal focussing (sektor 10 x 25).



sektor 8 x 22 Ww

Ref. No:	4288822
Magnification	8 x
Lens Ø	22 mm
Field of view	143 m/1000 m
Accessories	Belt bag, lens caps and carry cord.
Guarantee	5 years



sektor 10 x 25 Ww

Ref. No:	4288125
Magnification	10 x
Lens Ø	25 mm
Field of view	114 m/1000 m
Accessories	Belt bag, lens caps and carry cord.
Guarantee	5 years



sektor D – B compact

The sektor D *compact* binoculars have been made smaller and better.

- The image quality has been improved. The more efficient coating provides true colours and a brighter image.
- The enlarged field of view means that even larger areas can be seen.
- At the same time, the closer minimum focus lets the viewer “get even closer”.
- And last, but not least, people wearing glasses will be happy about the rotatable eyepieces: The cups do no longer retract unintentionally.

The 3 versions of the sektor D *compact* binoculars cover quite different requirements:

The 8 x 56 are the perfect hunting binoculars, but can also be used for bird- and nature watching during the twilight hours. Wildlife observation during the day is also fun with the 8 x 32 and 10 x 42. These two binoculars are particularly useful for holidays and travel as well as sports events.



Perfect hunting binoculars, even in twilight!



sektor D 8 x 32 B compact

Ref. No:	4272832
Magnification	8 x
Lens Ø	32 mm
Field of view	131 m/1000 m
Accessories	One-piece protective eyepiece and lens caps, socket for tripod adapter, padded carrying strap and waterproof case.
Guarantee	5 years



sektor D 10 x 42 B compact

Ref. No:	4272142
Magnification	10 x
Lens Ø	42 mm
Field of view	105 m/1000 m
Accessories	One-piece protective eyepiece and lens caps, socket for tripod adapter, padded carrying strap and waterproof case.
Guarantee	5 years



sektor D 8 x 56 B compact

Ref. No:	4272856
Magnification	8 x
Lens Ø	56 mm
Field of view	122 m/1000 m
Accessories	One-piece protective eyepiece and lens caps, socket for tripod adapter, padded carrying strap and waterproof case, tripod screw clamp.
Guarantee	5 years

For more technical data please see p. 34/35

adventure **B** *active*





Adventurers need a sturdy pair of binocs

Eschenbach Optik is the official supplier of the Land Rover Experience Tour and equips the participants in the off-road adventure with robust binoculars.

So you don't miss anything on a nature walk or outdoor adventure, a pair of binoculars is essential equipment for any expedition – the key word is robust, so they'll stand up to any knocks and jolts or dampness: that'll be the adventure *B active* then.



adventure 8 x 42 B active

Ref. No:	4270842
Magnification	8 x
Lens Ø	42 mm
Field of view	114 m/1000 m
Accessories	Padded carrying strap, one-piece protective eyepiece and lens caps, socket for tripod adapter and protective case.
Guarantee	5 years

adventure 8 x 42 B active

The "big one" for a particularly "big" picture. Even more robust and of course waterproof and nitrogen-filled, it withstands the most extreme challenges. Features such as the one-piece dust caps, the special tripod socket cover and the protective hard case make the adventure 8 x 42 B *active* a must for all outdoor activities!

Rugged, striking, easy grip – a real adventurer!



adventure 8 x 25 B active

Ref. No:	4295825
Magnification	8 x
Lens Ø	25 mm
Field of view	105 m/1000 m
Accessories	Protective dust caps, nylon bag with belt loop.
Guarantee	5 years

adventure 8 x 25 B active

For that small unexpected adventure!

Small but wow! - Ergonomically shaped and handy to use, the adventure *B active* monocular is always ready for action. Any time, any place: you'll always be equipped and fit for adventure. And as far as robustness and waterproofness goes, it's up there with the "biggie". The protective dust caps and nylon bag with belt loop protect the "little one" in the wildest of weathers.

The perfect companion!

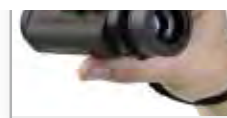

For more technical data please see p. 34/35



ESCHENBACH
Official Equipment

adventure B *active*

Striking design with far vision

Its rugged, striking shape won't just be popular with men. Women are also keenly aware of the benefits of strong, expressive designs.

The new adventure B *active* is tough and ready for the challenge. On land, on the water or in the air. Water-tight and exceptionally robust, the adventure B *active* is capable of coping with (almost) anything. Enjoy the excitement of the great outdoors – whatever the weather.

The BaK-4 prisms and full multi-coating provide exceptional image quality.



adventure 8 x 26 B *active*

Ref. No:	4270826
Magnification	8 x
Lens Ø	26 mm
Field of view	105 m/1000 m
Accessories	Padded carrying strap, one-piece protective eyepiece and lens caps, protective case.
Guarantee	5 years



adventure 10 x 26 B *active*

Ref. No:	4270126
Magnification	10 x
Lens Ø	26 mm
Field of view	96 m/1000 m
Accessories	Padded carrying strap, one-piece protective eyepiece and lens caps, protective case.
Guarantee	5 years





With an observation instrument you can get spectacular close-up views of even the shyest animals, as magnification is significantly higher than with traditional binoculars.

Spektive

- Relaxed viewing.
- Viewing with glasses/sunglasses easy with twist-up B eyepiece.
- Quick adjustment of magnification using zoom for moving objects etc.
- Vibration-free and steady image with tripod socket or table-top tripod.
- Compact design makes it easy to carry using the aluminium carrying case or carrying bag.

trophy® S zoom

- Easy location of objects using the "fix finder" scope.
- Robust, even in bad weather – nitrogen-filled and watertight.



trophy® S zoom

Ref. No:	46301
Magnification	15-45 x
Lens Ø	60 mm
Field of view	132-63 m/1000 m
Accessories	Carrying bag
Guarantee	10 years

vektor S zoom

- Quick and easy to use with stepless eyepiece adjustment.



vektor S zoom

Ref. No:	46311
Magnification	20-60 x
Lens Ø	70 mm
Field of view	32-18 m/1000 m
Accessories	Aluminium carrying case
Guarantee	10 years

For more technical data please see p. 34/35

arena®

Whether at a sporting event or going exploring on holiday – the arena® binoculars will help you to keep your perspective.

arena® F range

For every occasion

Small, light and convenient for everyday use. The new arena®-folding binoculars fit into any bag and are perfect for helping you get your bearings, whether you're on holiday, a walking trip or any kind of outdoor event. And with the new eyepieces for spectacle wearers, you'll always have a good view, even when wearing your (sun) glasses.



arena® F 8 x 21 B

Ref. No:	4255821
Magnification	8 x
Lens Ø	21 mm
Field of view	122 m/1000 m
Accessories	Belt bag and carry cord
Guarantee	5 years



arena® F 10 x 25 B

Ref. No:	4255125
Magnification	10 x
Lens Ø	25 mm
Field of view	96 m/1000 m
Accessories	Belt bag and carry cord
Guarantee	5 years

arena® P range

All-round binoculars at a good price

With a new design and improved specification, the arena® P binoculars will certainly continue to live up to their reputation. Perfect for nature watching, travel, and sports events. With the 3 wide-angle models featuring eyepieces for spectacle wearers, you'll always have an eye on the big picture even when following fast-moving action.

And the arena® P-Zoom binoculars allow you to bring interesting little details up to 24 x closer in next to no time. A special rubber housing makes the binoculars even easier to hold and more resilient.



arena® P 8 x 30 B Ww

Ref. No:	4241830
Magnification	8 x
Lens Ø	30 mm
Field of view	130 m/1000 m
Accessories	Tripod socket, bag and carrying strap
Guarantee	5 years



arena® P 10 x 40 B Ww

Ref. No:	4241140
Magnification	10 x
Lens Ø	40 mm
Field of view	114 m/1000 m
Accessories	Tripod socket, bag and carrying strap
Guarantee	5 years



arena® P 8-24 x 50 zoom

Ref. No:	42411
Magnification	8-24 x
Lens Ø	50 mm
Field of view	63 m/1000 m
Accessories	Tripod socket, bag and carrying strap
Guarantee	5 years



arena® P 7 x 50 B Ww

Ref. No:	4241750
Magnification	7 x
Lens Ø	50 mm
Field of view	105 m/1000 m
Accessories	Tripod socket, bag and carrying strap
Guarantee	5 years

For more technical data please see p. 34/35



vektor

Design "2000 +": The vektor series

Completely new binoculars with unconventional styling which draw attention with their compact and dynamic design. Dynamic, sporty, compact – almost a roadster for the eyes.

Old hands with binoculars, too, will be taken not just by their looks, but also by the optical/mechanical qualities at an excellent price for the performance provided:

The compact Porro optics have full multi coating and BaK-4 prisms and provide a sharp image with high colour fidelity.

Available as particularly compact 8 x 21, as 10 x 25 for higher magnification and as 5-15 x zoom for variable magnification.



zoom 5 x



zoom 15 x



vektor 8 x 21

Ref. No:	4229821
Magnification	8 x
Lens Ø	21 mm
Field of view	123 m/1000 m
Accessories	Belt bag, lens caps and carry cord
Guarantee	5 years

vektor 10 x 25

Ref. No:	4229125
Magnification	10 x
Lens Ø	25 mm
Field of view	91 m/1000 m
Accessories	Belt bag, lens caps and carry cord
Guarantee	5 years

vektor 5 – 15 x 21 Zoom

Ref. No:	42291
Magnification	5-15 x
Lens Ø	21 mm
Field of view	5 x 105 m/1000 m
Accessories	Belt bag, lens caps and carry cord
Guarantee	5 years



viva/magno®

Festival glasses viva V6

viva V6 is a stylish companion at all sporting events and cultural occasions, especially outdoors. Light as a feather, the binoculars have a very slim design, are incredibly easy to use, and have a wrist loop and slim belt case, making them handy to carry around at any event.

Its metallic coloured casing protects it from the hustle and bustle of the crowd.

The V6 will provide you with the best view of the stars from the back rows! Now you don't need to be in the front row to get close to the action on stage!

Supplied in a 2-pack.



Festival glasses viva V6 6

Ref. No:	84160615
Magnification	6 x
Lens Ø	15 mm
Field of view	157 m/1000 m
Accessories	Wrist strap and belt bag



magno® XF

Handy, foldable, offering particularly good value – magno® XF in new design.



magno® XF 8 x 21

Ref. No:	84172821
Magnification	8 x
Lens Ø	21 mm
Field of view	126 m/1000 m
Accessories	Belt bag and carry cord

magno® XF 10 x 25

Ref. No:	84172125
Magnification	10 x
Lens Ø	25 mm
Field of view	101 m/1000 m
Accessories	Belt bag and carry cord

For more technical data please see p. 34/35

Monoculars

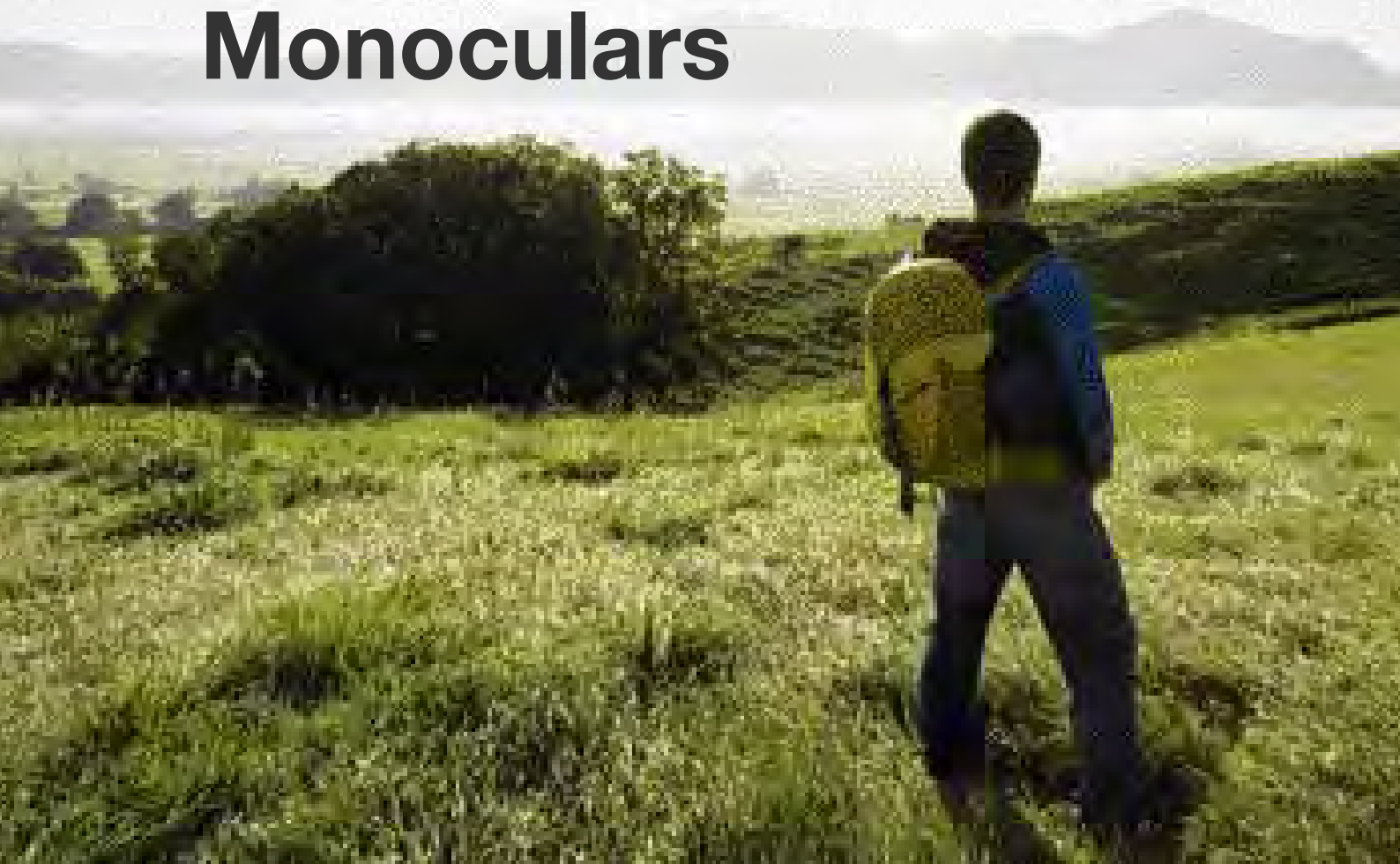

Extremely small and light. Monoculars are becoming increasingly popular. Whether on a nature watch or visiting the museum – a monocular doesn't weigh too heavily in a shirt pocket, is always close at hand, and is particularly easy to use – even at the theatre.

microlux 4 x 13

The smallest of monoculars.

Observation at the touch of a finger: The optical unit is protected in the small and light plastic casing of only 48 x 25 x 38 mm and extends into the observation position at a gentle touch.

So the microlux is a particularly small, light and practical companion for nature observation or a museum or theatre trip.

Turned "upside down", the microlux turns into a pocket magnifying glass with 3-times magnification.



microlux 4 x 13

Ref. No:	4294413
Magnification	4 x
Lens Ø	13 mm
Field of view	225 m/1000 m
Accessories	Carry cord and case
Guarantee	5 years



club® M

Offering extraordinary technology and design

The black rubber armouring is discreet, but tactile and makes easy single handed operation possible using sliding focussing. The fully-coated optics offers a new viewing experience due to its rectangular, panoramic field of view. The minimum focus of 1.5 m for the 6 x 16 and of only 2 m for the 8 x 16 allows near-range observation with magnification.



club® M 6 x 16

Ref. No:	4293616
Magnification	6 x
Lens Ø	16 mm x 12,5 mm
Field of view	122 m x 94 m/1000 m
Accessories	Leather case
Guarantee	5 years

club® M 8 x 16

Ref. No:	4293816
Magnification	8 x
Lens Ø	16 mm x 12,5 mm
Field of view	140 m x 108 m/1000 m
Accessories	Leather case
Guarantee	5 years

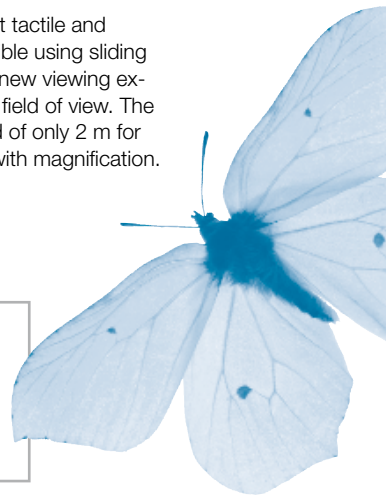

start® Monofold

Even smaller and even lighter

Very small Porro prisms are arranged within the foldable impact-resistant plastic housing in such a way that the dimensions of the monocular, when folded flat, are only approx. 7 x 4,5 x 2 cm. The fully-coated blue optics offer a good image quality and a short near point of 2 m despite its small size.



microlux 6 x 18

Ref. No:	4294618
Magnification	6 x
Lens Ø	18 mm
Field of view	142 m/1000 m
Accessories	Carry cord and case
Guarantee	5 years



start® Monofold

Ref. No:	4292821
Magnification	8 x
Lens Ø	21 mm
Field of view	113 m/1000 m
Accessories	Belt pouch
Guarantee	5 years



For more technical data please see p. 34/35



Night vision equipment

See in the dark – Night vision devices open up a hidden world of adventure and discovery. Even in the darkest conditions. For wildlife observations, for safety and supervision, for sailing or camping.

NONEXGEN NightScope

- First generation night scope.
- Compact and ultra-lightweight for convenient single-handed operation.
- 500 times intensification of available residual light.
- Manual activation of infrared.
- Robust housing with rubber surface.
- Battery included CR-123 3 Volt.



NONEXGEN

Ref. No:	841311
Magnification	2 x
Dimensions	14 x 5,7 x 9,5 cm
Accessories	Nylon bag

iGEN NV20/20

Visibility in perfect darkness

- Latest image processing technology – no conventional vacuum tube technology.
- Can also be used in day light.
- No halo effect.
- 650 times intensification of available residual light.
- Intelligent infrared (automatic adjustment to the light conditions).
- Better image quality with 30 line-pairs per millimetre edge to edge LCD resolution.
- Choice of different viewing colours for optimum viewing comfort.
- No image distortion due to poor cathode sensitivity.
- Real-time video output via RS 170 plug.
- More robust: no sensitive vacuum tube technology.
- 4 x 1.5 Volt AA batteries included.



iGEN NV20/20

Ref. No:	841391
Magnification	2,6 x
Dimensions	229 x 102 x 64 mm
Accessories	Tripod socket and case

LN-PB 3 x

Compact and tough binocular night vision device with infrared.

Aluminium body with partial rubber casing to ensure excellent grip. With multicoated optics for optimum image quality – even in the most challenging light conditions. The infrared makes it possible to see even in absolute darkness.

The sensitive components are protected from excessive glare by means of an integrated light protection sensor. This protects the image tube from damage.

- Weatherproof and sturdy aluminium body
- The high quality optics and 3 x magnification help to minimize light loss
- With built-in infrared and automatic light protection sensor.
- Generation 1+, high-resolution.
- Incl. batteries: 2 x 1.5 V 'LR1'



LN-PB 3 x

Ref. No:	841321
Magnification	3 x
Dimensions	165 x 115 x 56 mm
Accessories	Padded carry case and carrying strap

For more technical data please see p. 34/35

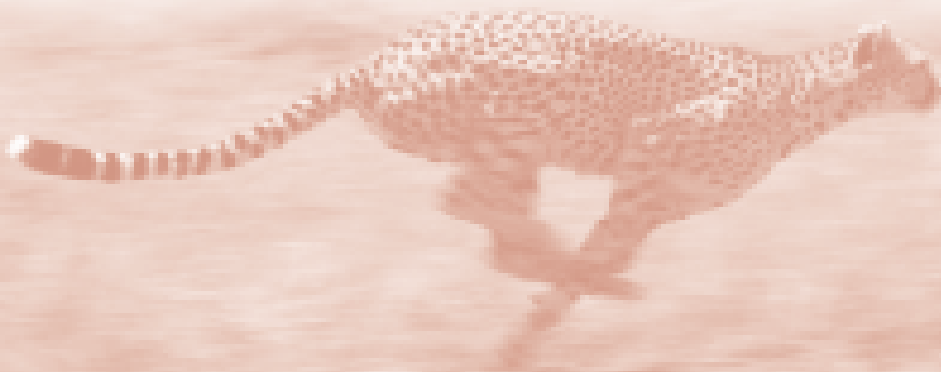

Binocular accessories

Binocular carrying strap



Ref. No: 419979

Tripod floor stand

A stable stand to ensure maximum comfort of use. With 3D panoramic head for infinitely variable adjustment. Integrated spirit level and quick coupling. Large, easy-grip guide handle. With crank for height adjustment of central column. Friction brake and stop brake ensure secure fixing.

Legs feature compact square profile (27 mm), with quick-set clamps. Cross brace and rubber feet with steel tips ensure stability.

Includes stand screw clamp for binoculars and practical carrying bag.

Height 65-160 cm, weight 1.820 g.

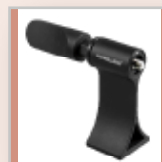

Ref. No: 4680

Opera- and theater glasses



Opera glasses collezione la scala

A select range of particularly small and discreetly designed opera glasses.



Ref. No: 4453
Description Dull-black body with silver eyepiece bridges and ornamental rings
Magnification 3 x
Lens Ø 18 mm
Accessories Black imitation leather case



Ref. No: 44551
Description In shimmering pearl white
Magnification 3 x
Lens Ø 18 mm
Accessories Black imitation leather case



Ref. No: 4454
Description Black soft leather finishing around the lens barrel and gold bridge sections as well as ornamental rings.
Magnification 3 x
Lens Ø 18 mm
Accessories Black imitation leather case



Ref. No: 44561
Description In stylish pearl gold
Magnification 3 x
Lens Ø 18 mm
Accessories Black imitation leather case





Vast numbers of people visit the opera, theatre, plays, concerts, cabarets and musicals. But theatre-goers, opera fans and music enthusiasts often experience one common problem: they don't always have front row seats. There's only one solution: treat yourself a pair of opera glasses!

Opera glasses with chain

Black and golden opera glasses with neck chain in cord design. The fashion accessory for all visits to the theatre, musicals and the opera. Chain cannot be removed.

Opera glasses glamour

Opera glasses in the classic "Paris" line. With such elegance the only question remaining is: "rouge" ou "bleu"?



Ref. No: 4451
Description Finely embossed, black leather covers the lens barre.
Magnification 3 x
Lens Ø 23 mm
Accessories Black imitation leather case



Ref. No: 44681
Magnification 3 x
Lens Ø 25 mm
Accessories case







Ref. No: 44501
Description In spectacular night blue
Magnification 3 x
Lens Ø 23 mm
Accessories Black imitation leather case











Ref. No: 4452
Description With extravagant burgundy Chinese-effect lacquer.
Magnification 3 x
Lens Ø 23 mm
Accessories Black imitation leather case



Technical Data

Optical Parameters as per DIN 58386, 58388





	 regatta®	 club® W	 farlux® SELECTOR D	 farlux® SELECTOR V	 farlux® F	
Order number	4250842 B	4265825 B	4274845 B	42741 B	42848241 B	42841281 B
Magnification	8 x	8 x	8.5 x	8-15 x zoom	8 x	10 x
Objective-Ø (mm)	42	25	45	35	24	28
Exit pupil (mm)	5.25	3.1	5.3	4.4-2.3	3.0	2.8
Geometric light beam	27.6	9,8	28.0	19.4-5.3	9.0	7.8
Twilight power	18,3	14.1	19.6	16.7-22.9	13.9	16.7
Field of View/1000 m	113	96	117	91-70	109	86
Near Point (m)	2.5	2	3	3	3	4
Min./Max. Pupil distance (mm)	60/70	60/70	58/74	56/74		35/72
Height (mm)	160	110	156	156	98	109
Weight w/o pouch (g)	714	345	810	900	250	260
Page	p. 6	p. 8	p. 11	p. 12	p. 13	p. 13

	 sektor D compact			 sektor F Ww		 adventure B active		 adventure B active	
Order number	4272832 B	4272142 B	4272856 B	4288822	4288125	4270842 B	4295825 B	4270826 B	4270126 B
Magnification	8 x	10 x	8 x	8 x	10 x	8 x	8 x	8 x	10 x
Objective-Ø (mm)	32	42	56	22	25	42	25	26	26
Exit pupil (mm)	4.0	4.2	7.0	2.75	2.5	5.25	3.13	3.25	2.6
Geometric light beam	16.0	17.6	49.0	7.6	6.25	27.6	9.8	10.6	6.8
Twilight power	16.0	20.5	21.1	13.3	15.8	18.3	14.1	14.4	16.1
Field of View/1000 m	117	98	114	143	114	114	105	105	96
Near Point (m)	4	4	4	3	3	3.0	5.0	2.5	2.5
Min./Max. Pupil distance (mm)		59/73	57/70		32/74	56/74	Mono		54/74
Height (mm)	125	150	190	105	105	145	106	104	104
Weight w/o pouch (g)	790	820	1390	260	270	750	100	290	295
Page	p. 19	p. 19	p. 19	p. 18	p. 18	p. 21	p. 21	p. 22	p. 22

	 magno® XF		 viva V6	 microlux		 club® M		 start® Monofold
Order number	84172821	84172125	84160615	4294618	4294413	4293616	4293816	4292821
Magnification	8 x	10 x	6 x	6 x	4 x	6 x	8 x	8 x
Objective-Ø (mm)	21	25	15	18	13	16	16	21
Exit pupil (mm)	2.6	2.5	2.5	3	3.3	2.7	2.0	2.6
Geometric light beam	6.9	6.25	6.3	9.0	10.5	7.1	4.0	6.9
Twilight power	12.9	15.8	9.5	10.4	7.2	9.8	11.3	13.0
Field of View/1000 m	126	101	157	142	225	140 x 108	122 x 94	113
Near Point (m)	4	4	3	-	-	1.5	2	2
Min./Max. Pupil distance (mm)		32/74	57/72		Mono		Mono	Mono
Height (mm)	95	112	85	42/63	38/58	82	82	50
Weight w/o pouch (g)	215	245	100	78	46	68	68	90
Page	p. 27	p. 27	p. 27	p. 28	p. 28	p. 29	p. 29	p. 29

 trophy® D			 trophy® P			 trophy® F	
4282832 B	4282742 B	4282150 B	4237840 B	4237150 B	4237856 B	42878252 B	42871252 B
8 x	7 x	10 x	8 x	10 x	8 x	8 x	10 x
32	42	50	40	50	56	25	25
4.0	6.0	5.0	5.0	5.0	7.0	3.1	2.5
16.0	36.0	25.0	25.0	25.0	49.0	9.6	6.25
16.0	17.1	22.4	17.9	22.4	21.1	14.1	15.8
131	114	88	143	114	102	92	87
2	3	4	4	8	8	2	2
	59/73			59/71			34/75
123	152	170	142	175	183	110	110
680	761	863	990	1150	1190	300	300
p. 15	p. 15	p. 15	p. 16	p. 16	p. 16	p. 17	p. 17

B = Eyepieces with long Eyerelief
Ww = Wide field
D = Roof prism
P = Porro prism
F = Folding binoculars

 trophy® S	 vektor S	 arena® F	 arena® P	 vektor						
46301 B	46311 B	4255821 B	4255125 B	4241830 B	4241140 B	4241750 B	42411	4229821	4229125	42291
15-45 x zoom	20-60 x	8 x	10 x	8 x	10 x	7 x	8-24 x zoom	8 x	10 x	5-15 x zoom
60	70	21	25	30	40	50	50	21	25	21
4.0-1.3	3.5-1.2	2.6	2.5	3.8	4.0	7.1 x	6.3-2.0	2.6	2.5	4.2-1.4
16-1.7	12.3-1.4	6.8	6.3	14.4	16.0	50.4	39.7-4.0	6.9	6.25	17.6-2.0
30-52	37.4-64.8	13.0	15.8	15.5	20.0	18.7	20.0-34.6	13.0	15.8	10.3-17.8
132-63	32-18 m	122	96	130	114	105	63	123	91	105 (at 5 x)
5	6.5	6	6	8	8	8	12	2	3	2.5
	Mono		40/73	60/74	60/74	60/74	60/74	60/71	60/74	60/73
Length 320	Length 425	100	120	131	157	174	179	80	108	97
995	1796	277	300	855	980	1020	995	180	320	180
p. 23	p. 23	p. 24	p. 24	p. 25	p. 25	p. 25	p. 25	p. 26	p. 26	p. 26

 iGEN NV20/20	 NONEXGEN	 LN-PB 3 x
841391	841311	841321
2,6 x	2 x	3 x
-	-	-
-	-	-
-	-	-
21/70	21/61	200
-	-	-
Mono	Mono	Fix 59/69
64	95	165
542	280	760
p. 30	p. 30	p. 31





ESCHENBACH

Eschenbach Optik GmbH
Schopenhauerstraße 10
90409 Nürnberg

Telefon 0911 3600 -0
Fax 0911 3600 -358
Internet www.eschenbach-optik.de
www.freizeitoptik.de
E-mail mail@eschenbach-optik.de

