

# Vision Technology Products



**Magnifiers, Telescopes, Magnifying Eyewear,  
Video Magnifiers and more!**

Now  
including ASH  
Video Magnifiers  
(Pg. 44-48)

 **ESCHENBACH OPTIK**  
Better vision. Better life.

Eschenbach's worldwide and administrative headquarters (top) and modern research and development technology center (bottom).



## Why Magnifying Vision Aids?

Generally speaking, magnifying vision aids can help a visually impaired person to see better in order to carry out their daily living tasks independently, thereby providing a better quality of life.

A visual impairment exists when, despite applying the best corrective glasses or contact lenses, vision is still impaired. The most frequent causes in the western part of the world are age-related macular degeneration (AMD), diabetic retinopathy, cataracts, and glaucoma.

With age-related **macular degeneration**, only the peripheral section of the retina can be used to see, as the retina is destroyed in the visual center called the macula.

In **diabetic retinopathy**, the function of the retina is disturbed in small islands. At the advanced stage, the islands grow together to form large-field areas.

A **cataract** is clouding of the lens of the eye, which leads to increased sensitivity to flashes of light in addition to impairment of the Snellen Acuity.

**Glaucoma** is increased internal pressure in the eye that leads to irreversible damage to the optic nerve. With simple glaucoma, central vision remains intact for a long time.

**Retinitis pigmentosa**, due to the death of the rods in the retina causes the field of view to narrow increasingly to a tubular field of view. Retinitis pigmentosa can lead to blindness.



Normal Vision

## A world brand with tradition

Eschenbach Optik GmbH was founded by Josef Eschenbach in 1913 as a wholesaler of optical products and precision drawing instruments.

In order to meet the strong demand for Eschenbach optical products, the first subsidiaries in Austria and Switzerland were created in the 1960's under the leadership of the brothers Gerd and Walter Eschenbach. Subsidiaries followed in Italy, France, Denmark, the Netherlands, Spain, the Czech Republic, and North America.

With more than 30 other trade partners throughout the world, as well as a joint venture in Japan, Eschenbach has developed into the world leader for optical products.

From spectacle frames to sunglasses to binoculars and reading glasses, magnifiers and special vision aids – the

Eschenbach name has come to mean a comprehensive range of products, quality and innovation.

### Vision Technology Products

As there is more to the magnifying vision aid product range than magnifiers and reading glasses, we have given this sector a new name:

"Vision Technology Products" stands for the high degree of precision and accuracy achieved by Eschenbach through the use of the latest technologies and manufacturing processes.

Investing in the company's own research and development department is an essential pre-condition for the famous Eschenbach quality. As always, Eschenbach is committed to tangible progress – for our customers' satisfaction.



Macular Degeneration



Diabetic Retinopathy



Cataract

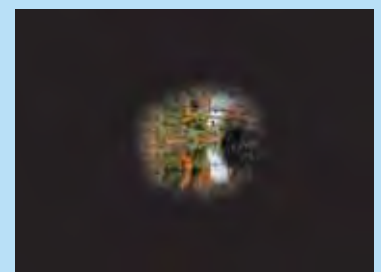

Glaucoma or Retinitis Pigmentosa



**The Visible Progress**

The Visible Progress refers to new technology at Eschenbach where refraction and diffraction of light are combined.

**cera-tec®**

cera-tec® is a hard coating developed in collaboration with the Fraunhofer Institute for Silicate Research ISC (Würzburg) specifically for PXM® lenses on ORMOCER® basis.

In addition to high scratch-resistance, cera-tec® has substantially improved chemical resistance.

Our coating procedures offer all-around lens protection as all lenses are coated on both the front and back surface.

The finished product sets new standards in quality, service life, reliability and economy.

**PXM® lightweight lenses**

Eschenbach lenses are made of PXM® material. This material is characterized by its light weight and high resistance to breakage.

As a result, Eschenbach customers have a choice of products with the highest image quality, economic design and maximum utility.

**Ease of Use Rating Guide**

In consultation with eye care and rehab professionals, Eschenbach Optik has developed a unique 'Ease of Use' scale for each of our products.

As you browse through the catalog, use the color coded scale below to determine the amount of training your patient will need to find success with each product.

Products at the lower end of the 'Easy to use' scale require little or no training for successful application, while products at the higher end will require training, fitting and assistance from an eye care or rehab professional for users to achieve success.

Each product in this catalog is rated from 1-5, with 1 indicating that little or no patient training is needed, and 5 indicating training is required.

- 1 - 1 **Easy to use**
- 2 - 2 **Somewhat easy to use**
- 3 - 3 **Moderately easy to use**
- 4 - 4 **May require training**
- 5 - 5 **Requires training**

**Contents**

	<b>Introduction</b>	2-3
	<b>Hand-held Magnifiers</b> Illuminated Aspheric Aplanatic Biconvex Hand-held/Stand combinations Folding Pocket + Pendant	4 - 14
	<b>Stand Magnifiers</b> Illuminated Non-Illuminated Bar Bright Field Lamp Magnifiers Gooseneck Around the Neck	15-23
	<b>Reading Glasses</b> Readers Lorgnettes	24
	<b>Spectacle Magnifiers</b> Head Band & Clip-on Systems noves Magnifying Eyewear Prismatic Eyewear Microscopes ClearImage II	25-30
	<b>Telescopes</b> Galilean Keplerian Telescope Carrier Systems Telescope Kit	31-41
	<b>Absorptive Filters</b> Solar Shields® Solar 3s	42-43
	<b>Video Magnifiers</b> Portable Hand-held Portable Desktop Transportable Desktop Desktop Portable Desktop w/Distance Camera Trans. Desktop w/ Distance Camera	44-48
	<b>Technical Magnifiers</b> Hand-held Stand	49-53
	<b>Non-Optical Products</b> Task Lighting Accessories Diagnostic Dispensing Systems	54-59
<b>Technical Data &amp; Index</b>		60-63

# Hand-held Magnifiers

■ Illuminated



*"At last I no longer need to ask about size or price when purchasing. With Mobilux I can read the small print on the labels again!"*

## Mobilux

### Illuminated Hand-held Magnifiers:

- Provide magnification and illumination for spotting tasks
- Ideal for in-home uses such as looking up a phone number, setting the thermostat or reading the prescription on a medicine bottle
- Portability makes them useful for spotting a price in the supermarket, reading the menu in a dimly lit restaurant, or looking at a map in the car

### 1510 Series

#### Special Features:

- Superior quality aspheric lens
- Hinge on handle keeps top and bottom pieces together and eliminates alignment problems when closing the handle
- Noted for its simple maintenance in changing batteries and bulbs
- Large raised on/off switch is easy for arthritic fingers
- 1510-2, 1510-3, 1510-5, and 1510-41 have a storage compartment in the handle containing a spare bulb (included)

#### Technical Information:

**Lens:** Aspheric PXM® lightweight lens with cera-tec® coating

**Bulb:** Incandescent replacement bulb 1544

**Mount:** High grade white plastic

**Batteries:** Requires 2AA batteries (included)

**Case:** Protective cases are available.

See table below for order number.

### Illuminated Hand-held Magnifiers

Product #	Lens Size (mm)	Dpt.	Magnification	Case #
<b>1510-2</b>	60	12	3x	<b>1500-4</b>
<b>1510-3</b>	75 x 50	10	3.5x	<b>1500-4</b>
<b>1510-41</b>	60	16	4x	<b>1500-4</b>
<b>1510-5</b>	60	20	5x	<b>1500-4</b>
<b>1510-7</b>	35	28	7x	<b>1500-1</b>
<b>1510-10</b>	35	38	10x	<b>1500-1</b>
<b>1510-12</b>	30	50	12.5x	<b>1500-1</b>

### Protective Cases

Protective cases are available for all of our illuminated magnifiers. The magnifier model number is shown next to each case number.

Case #	Magnifier #
<b>1500-1</b>	1510-104, 1510-124, 1510-74, 1510-10, 1510-12, 1510-7, 1571
<b>1500-4</b>	1510-24, 1510-34, 1510-44, 1510-54, 1510-2, 1510-3, 1510-41, 1510-5, 1572, 1573, 1575

Protective cases are made from lint free fabric with locking drawstring.

### 1512-9 Hand-Held Magnifier Display for 1510 Magnifiers

#### Special Features:

The 1512-9 Point-of-Purchase display was specifically designed to hold 9 magnifiers from our most popular 1510-illuminated magnifier line. Give your patients the opportunity to examine a wide variety of magnifiers in the waiting room or in the dispensary. The 1512 display will fit in a small space on most counter tops and is free when any nine 1510 magnifiers are purchased.



1=easy - 5=requires training

1510-2

1



1510-3

1



1510-41

2



1510-5

2



1510-7

3



1510-10

3



1510-12

4



1512-9

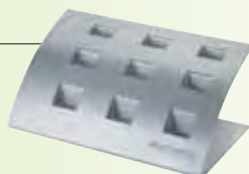

# Hand-held Magnifiers

■ Illuminated

## Mobilux LED



LED (light emitting diode) illumination provides an alternative light source preferred by many patients due to its distinctly whiter spectrum and longer useful life. In addition to the LEDs offering nearly unlimited life, the batteries last 5 times longer than those used with incandescent bulbs! These features provide lower usage costs and make the magnifiers easier to use!

To soften the color of the light, small yellow filters are available. These can be snapped-on over the LED bulbs to provide an alternative illumination option.

**Technical Information:**

**Lens:** Aspheric PXM® with cera-tec® hard coating and detachable cover

**Illumination:** 1 LED

**Mount:** High-grade white plastic

**Batteries:** Requires 2 AA batteries (included).

**Case:** Protective case available. See table below.

Product #	Lens Size (mm)	Dpt.	Magnification	Case #
1510-24	60	12	3x	1500-4
1510-34	75 x 50	10	3.5x	1500-4
1510-44	60	16	4x	1500-4
1510-54	60	20	5x	1500-4
1510-74	35	28	7x	1500-1
1510-104	35	38	10x	1500-1
1510-124	30	50	12.5x	1500-1

### 15107

**Diagnostic tray of Illuminated Pocket Magnifiers**

ESCHENBACH's broad assortment of illuminated pocket magnifiers in one convenient display tray. The assortment features a range of magnification from 3x to 12.5x, as well as both LED and incandescent light sources.

Contents: 11 pieces

1510-2, 1510-3, 1510-41, 1510-5, 1510-24, 1510-34, 1510-44, 1510-54, 1510-74, 1510-104, 1510-124. Tray insert 15107-304 is included at no charge with purchase of assortment.

Optionally available:

1880 white display tray with 1882-2 acrylic cover.



15107



1510-24

1



1510-34

1



1510-44

2



1510-54

2



1510-74

3



1510-104

3



1510-124

4

# Hand-held Magnifiers

■ Illuminated

1521-10

1



1521-11

1



1521-22

1



1521-1907



1571

2



1572

1



1573

1



1575

1



## easyPOCKETS

Are your patients looking for a small, illuminated magnifier they can take with them everywhere? The easyPOCKET is a perfect choice for them! It's available in 3x and 4x magnifications, has an aspheric/diffractive distortion-free lens, SMD LED illumination, and a strong fiber-glass-reinforced case for lens protection. Plus, the lens is only 3 mm thick! The easyPOCKET is manufactured with LED bulbs that never need to be changed and the flat button battery (included) has a 3+ hour life span. The light can never be left on accidentally due to the design, as the light will go on and off automatically when the device is open and closed. Fits in any pocket or purse.

Product #	Lens Size (mm)	Dpt.	Magnification	Case Color
1521-10	50 x 46 mm	12	3x	Black
1521-11	50 x 46 mm	12	3x	Silver
1521-22	50 x 46 mm	16	4x	Metallic Blue

### 1521-1907 easyPOCKET Display

#### Special Features:

The 1521-1907 Point-of-Purchase display holds 6 easyPOCKET magnifiers and is FREE with the purchase of any 6 easyPOCKETS. You'll be able to select your choice of colors and magnification.

## Economy

### 1570 Series

The 1570 Series is an economical line of low-powered illuminated hand-held magnifiers that are ideal for reading maps, menus, price tags or other objects, especially in dark settings.

#### Special Features:

- Lightweight biconvex lens facilitates binocular viewing
- Large field of view
- Wider, easy-to-see black switch
- 1572, 1573 and 1575 have a storage compartment in the handle for a spare bulb (not included)

#### Technical Information:

**Lens:** Biconvex, PXM® lightweight lens with duplex coating

**Bulb:** Incandescent replacement bulb 1543

**Mount:** High grade white plastic

**Batteries:** 2 AA batteries (included)

**Case:** Protective cases are available. See below for order number.

Product #	Lens Size (mm)	Dpt.	Magnification	Case#
1571	30	21.0	6x	1500-1
1572	60	10.0	3.5x	1500-4
1573	80	5.4	2.5x	1500-4
1575	75 x 50	5.0	2.5x	1500-4



1=easy - 5=requires training

# Hand-held Magnifiers

■ Aspheric

## ■ Aspheric

### The Aspheric Lens:

This lens type has steeper curves which allow for higher magnification with less distortion.

### 2655 Series - Aspheric Hand-held Magnifier

#### Special Features:

- Ergonomic handle design makes it comfortable to hold
- Specially calculated lenses provide distortion-free viewing
- Positioning of handle makes 2655 series suitable for left-handed users!
- Comes with carrying cord to wear around the neck

#### Technical Information:

**Lens:** Aspheric PXM® lightweight lens with cera-tec® coating

**Mount:** Black matte plastic

**Handle:** Black matte plastic

**Eye to Lens Distance (mm):** Printed on handle.

**Note:** Blue loop at the end of the handle can slide out for use with the carrying cord which is provided. All 2655 magnifiers are suitable for left-handed use.

Product #	Lens Size (mm)	Dpt.	Magnification	Case #
<b>2655-50</b>	50	24	6x	<b>2855-50</b>
<b>2655-60</b>	60	20	5x	<b>2855-60</b>
<b>2655-70</b>	70	16	4x	<b>2855-70</b>
<b>2655-750*</b>	75x50	10	3.5x	<b>2855-150</b>
<b>2655-150*</b>	100x50	7.6	3x	<b>2855-150</b>
<b>2655-175*</b>	100x75	7.0	2.8x	<b>2855-175</b>

\* Can be used with the Super-Lite 2090-04. See page 54



*"Reading can be so easy with the right magnifier!"*



cera-tec®  
coating



**2655-50**

2



**2655-60**

2



**2655-70**

2



**2655-750**

1



**2655-150**

1



**2655-175**

1



**2845**

### 2845

#### Diagnostic Tray of Aspheric Magnifiers

Contents: 6 pieces

2655-50, 2655-60, 2655-70, 2655-750, 2655-150, 2655-175. Order cases individually as listed above or as case assortment 2845-C. Tray insert 2845-3 is included at no charge with purchase of assortment.

Optionally available:

1880 white display tray with 1882-2 acrylic cover.

# Hand-held Magnifiers

■ Aplanatic

2668-50

1



2668-60

1



2668-75

1



2668-85

1



2668-950

1



2815-04



2668-9



## Ergo Aplanatic

### The Aplanatic Lens:

The Aplanatic lens, a proprietary design of ESCHENBACH, offers the best optics available in magnifiers. The aplanatic lens is made of a high-quality PXM® lightweight lens system consisting of two plano-convex lenses that give a clearly defined, distortion-free image. Because of the edge-to-edge distortion-free optics, this lens design is especially useful for patients with macular degeneration.

### Special Features:

- Excellent distortion-free optics
- Ergonomic handle
- Lightweight

### Technical Information:

**Lens:** Aplanatic PXM® lightweight lens

**Mount:** High grade plastic

**Handle:** Ergonomic design, soft plastic handle

**Case:** Black draw-string case #1500-4 is available. See page 4.

Product #	Lens Size (mm)	Dpt.	Magnification
<b>2668-50</b>	50	14.0	4.5x
<b>2668-60</b>	60	11.3	3.8x
<b>2668-75</b>	75	7.4	2.8x
<b>2668-85</b>	85	5.6	2.4x
<b>2668-950</b>	90x50	6.8	2.7x

### 2815-04 Aplanatic and Biconvex Assortment

Diagnostic tray of biconvex and aplanatic hand-held magnifiers.

#### Contents: 9 pieces

2614-150, 2614-65, 2614-80, 2614-840, 2668-50, 2668-60, 2668-75, 2668-85, 2668-950. Tray-insert 2815-1304 included at no charge with purchase of assortment.

Optionally available:

1880 white display tray with 1882-2 acrylic cover.

### 2668-9 Hand-held Ergo Magnifier Display

An attractive Ergo Hand-held magnifier display that holds an assortment of 6 Ergo-style magnifiers. The display is FREE with the purchase of any 6 Ergo magnifiers.



1=easy - 5=requires training

# Hand-held Magnifiers

■ Biconvex

## Large Field

The Large Field series of Biconvex hand-held magnifiers offers the largest fields available in their power range.

**Special Features:**

- Large field biconvex lens
- Transparent mount for shadow-free viewing
- 5x bifocal lens in handle
- Carrying cord included - fits into slot in handle

**Technical Information:**

**Lens:** Biconvex PXM® lightweight lens with anti-static coating

**Bifocal:** Plano-convex

**Mount:** Transparent PXM®

**Handle:** Shell-type patented design. Black plastic w/slot for carrying cord.

**Case:** Black leather cases available, see order numbers below.

Product #	Lens Size (mm)	Dpt.	Magnification	Case #
<b>2642-65</b>	65	7.4	3x	<b>2872-65</b>
<b>2642-80</b>	80	5.1	2.5x	<b>2872-80</b>
<b>2642-100</b>	100	3.9	2x	<b>2872-100</b>
<b>2642-120</b>	120	3.2	2x	<b>2872-120</b>
<b>2642-840</b>	80x40	5.0	2.5x	<b>2872-840</b>
<b>2642-150</b>	100x50	3.9	2x	<b>2872-150</b>
<b>2642-1255</b>	120x55	3.3	2x	<b>2872-1255</b>

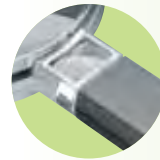

2642-65

1



2642-80

1



2642-100

1



2642-120

1



2642-840

1



2642-150

1



2642-1255

1

# Hand-held Magnifiers

■ Biconvex

2612-407

1



2612-607

1



2612-807

1



2612-9507

1



2612-1

1



1854



New Product!

## Economy

The Economy Series of Biconvex hand-held magnifiers offers high-quality optics at an affordable price.

### Economy Series Special Features:

- Completely transparent for maximum light and shadow-free viewing
- 5x plano-convex bifocal lens in handle
- Slot in handle for carrying cord (cord not included)

### Technical Information:

**Lens:** Biconvex PXM® lightweight lens

**Bifocal:** Plano-convex

**Mount:** Transparent PXM®

**Handle:** Transparent PXM® with 5x bifocal and slot for carrying cord

Product #	Lens Size (mm)	Dpt.	Magnification	Quantity per pkg.
2612-401	40	8.4	3.25x	6
2612-407	40	8.4	3.25x	1
2612-601	60	6.4	2.5x	6
2612-607	60	6.4	2.5x	1
2612-801	80	5	2.5x	6
2612-807	80	5	2.5x	1
2612-9501	90x50	3.9	2x	3
2612-9507	90x50	3.9	2x	1

### 2612-1 Display with 12 Hand-held Magnifiers

This contemporary presentation fits easily on any counter or table and holds 12 of our popular 2612 series hand-held magnifiers. Let your patients view and examine all of these products at the check-out desk, in the waiting room, or wherever the display is placed.

The 2612-1 Display of biconvex hand-held magnifiers, with a magnification range of 2x - 3.25x, includes an assortment of twelve magnifiers: four 2612-9507 magnifiers, three 2612-807 magnifiers, three 2612-607 magnifiers, and two 2612-407 magnifiers.

### 1854 Eschenbach Retail Display

#### Special Features:

The 1854 Retail Display practically sells itself. It contains a select assortment of 10 of our most popular magnification devices (from 1.9D to 16D). The back panel (in English, French, Spanish or Portuguese) and acrylic base display are free with the purchase of the 10 piece assortment.

The assortment includes one of each of the following: 1 MaxTV (1624-1), 3 illuminated hand-held magnifiers (1510-24, 1510-34, 1510-44), 2 folding magnifiers (1752-860, 1740-160), and 4 hand-held magnifiers (2612-407, 2612-607, 2612-807, 2612-9507).

# Hand-held Magnifiers

■ Biconvex

## ■ Visomed

### Biconvex Visomed Series

#### Special Features:

The 2614 series of hand-held magnifiers features low magnification and a large field of view. These attributes make them ideal for early intervention for low vision patients needing extra magnification for such daily living tasks as reading small print labels, looking up telephone numbers, or reading the stock market pages.

#### Technical Information:

**Lens:** Biconvex PXM® lightweight lens with anti-static coating

**Mount:** Transparent PXM®

**Handle:** High-grade white plastic

**Case:** Black leather cases available – see below

Product #	Lens Size (mm)	Dpt.	Magnification	Case #
<b>2614-65</b>	65	7.4	3x	<b>2872-65</b>
<b>2614-80</b>	80	5.1	2.5x	<b>2872-80</b>
<b>2614-840</b>	80 x 40	6.0	2.5x	<b>2872-840</b>
<b>2614-150</b>	100 x 50	3.9	2x	<b>2872-150</b>



2614-65

1



2614-80

1



2614-840

1



2614-150

1

### 2815-04

#### Diagnostic Tray of Aplanatic and Biconvex Magnifiers

This display tray contains our complete assortment of “Ergo” 2668 hand-held magnifiers, as well as our 2614 series of biconvex magnifiers.

Contents: 9 pieces

2614-150, 2614-65, 2614-80, 2614-840, 2668-50, 2668-60, 2668-75, 2668-85, 2668-950. Tray insert 2815-1304 included at no charge with purchase of assortment.

Optionally available:

1880 white display tray with 1882-2 acrylic cover.

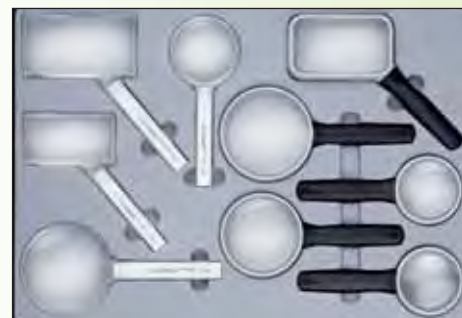

2815-04



1=easy - 5=requires training

# Hand-held Magnifiers

## ■ Hand-held/Stand Combinations

2050-1

1



2050-19



## ■ Visoflex

**2050-1**

**Combination Hand/Stand/Pocket Magnifier**

**Special Features:**

The 2050-1 has an ultra-modern, functional design that is small enough to be portable. The design offers three different types of magnifier in one! (See adjacent photos).

**Technical Information:**

**Magnification:** 2.5x (10D)

**Lens:** Biconvex

**Lens Size:** 60 mm

**Mount:** ABS plastic-black

**Case:** 1500-4 case available

**2050-19**

**Viso-flex Display**

**Contents:** 4 of 2050-1

Display base included at no charge with purchase of assortment.

Displays three of the four 2050-1's.

2031

1



## ■ Combi-plus



2032

1



**Combination Hand-held/Stand Magnifiers**

**Special Features:**

This series is designed to offer two magnifiers in one! First, the magnifier can be used as a standard hand-held magnifier. Second, with the metal legs unfolded, it can be used either as a fixed stand magnifier or, in the tilted down position, it can be used as an inclined stand magnifier. For portability, simply fold in the metal legs, fold in the handle and slide it into its leather case!

**Technical Information:**

**Lens:** Aspheric PXM® lightweight lens with cera-tec® coating

**Mount:** White or Black Plastic

**Handle:** Black Plastic

**Case:** Comes complete with black leather case

2034

1



Product #	Lens Size (mm)	Dpt.	Magnification
2031*	100 x 50	6.3	2.8x
2032*	100 x 75	7	2.8x
2034*	75 x 50	10	3.5x
2036*	100 x 50	6.3	2.8x

\* Can be used with 1604-104 Bar Light. See page 54.

2036

1



1=easy - 5=requires training

# Hand-held Magnifiers

## Folding

### Classic

The Classic collection offers a variety of colors and styles that make these leather folding pocket magnifiers functional and stylish.

**Technical Information:**

**Magnification:** 3.5x and 6x

**Lens:** Biconvex, PXM® lightweight lenses

**Lens Size:** 30 mm, 50 mm or 60 mm

**Mount:** Transparent plastic

**Case:** Leather case, various colors (see listing below)

Product #	Lens Size (mm)	Dpt.	Magnification	Case Style and Color
1740-130	30	24	6x	Grained, red
1740-150	50	10	3.5x	Grained, red
1740-160	60	10	3.5x	Grained, red
1740-250	50	10	3.5x	Grained, pine-green
1740-260	60	10	3.5x	Grained, pine-green
1740-450	50	10	3.5x	Grained, brown
1740-460	60	10	3.5x	Grained, brown
1740-530	30	24	6x	Grained, black
1740-550	50	10	3.5x	Grained, black
1740-560	60	10	3.5x	Grained, black
1752-150	50	10	3.5x	Fine grain, maroon
1752-160	60	10	3.5x	Fine grain, maroon
1752-550	50	10	3.5x	Fine grain, black
1752-560	60	10	3.5x	Fine grain, black
1752-850	50	10	3.5x	Fine grain, tan
1752-860	60	10	3.5x	Fine grain, tan

### 1741-103 Display of Folding Pocket Magnifiers

**Special Features:**

This contemporary display fits easily on any counter and holds 16 of our most popular, hand-held folding pocket magnifiers. It allows your patients to view and examine them at the check-out desk, in the dispensary, or wherever the display is placed. Each magnifier comes with an attached, colorful case (green, brown, red or black) to protect the lens from dust and scratches. The display is free when the 16-piece assortment is purchased.

**The assortment of folding magnifiers includes:**

**10 Round Folding Magnifiers**

- Two 30 mm magnifiers (6x magnification)
- Four 50 mm magnifiers (3.5x magnification)
- Four 60 mm magnifiers (3.5x magnification)

**6 Square Folding Magnifiers**

- Three 50 mm magnifiers (3.5x magnification)
- Three 60 mm magnifiers (3.5x magnification)

### 1741-119 Folding Magnifiers Display Only

A silver colored, functional POP [point-of-purchase] display with space for 16 folding magnifiers of various shapes and magnification.

### 2822-04

**Diagnostic Tray of Pocket and Bright Field Magnifiers**

Contents: 11 pieces:

1420, 1436, 1710-14, 1710-67, 1710-910, 1740-160, 1740-530, 1752-850, 2050-1, 2605, 2678. Tray insert 2822-304 included at no charge with the purchase of the assortment.

Optionally available:

1880 white tray base and 1882-2 acrylic cover



1740-130 2  
1740-150 1  
1740-160 1



1740-250 1  
1740-260 1



1740-450 1  
1740-460 1



1740-530 2  
1740-550 1  
1740-560 1



1752-150 1  
1752-160 1



1752-550 1  
1752-560 1

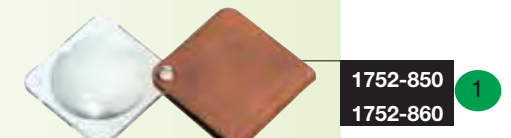

1752-850 1  
1752-860 1



1741-103 1



2822-04

# Hand-held Magnifiers

## ■ Pocket & Pendant

1711

2



1710-14

2



1710-67

2

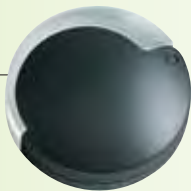

1710-910

3



2136-1

1



2136-2

1



## ■ Designo

### 1711

The Designo biconvex pocket magnifier features a compact sliding case that protects this powerful pocket magnifier.

#### Technical Information:

**Magnification:** 5x (20D)

**Lens:** Biconvex

**Lens size:** 30 mm

**Mount:** ABS plastic-black

## ■ Mobilent

### 1710

Eschenbach has employed the latest technology and manufacturing methods to design the lens and case of this unique folding pocket magnifier in a single unit.

#### Special Features:

- High magnifications in a compact size
- Case design provides complete protection for the lens
- Small size fits easily into a pocket or purse
- Includes a carrying cord which can be threaded through hinge

#### Technical Information:

**Lens:** Bi-aspheric PXM® lightweight lenses

**Lens Size:** 35 mm

**Case:** Strong, fine grained plastic

**Eye to Lens Distance (mm):** Printed on case

**Note:** Comes complete with carrying cord

Product #	Color	Dpt.	Magnification
1710-14	Red Cover	16	4x
1710-67	Gray Cover	28	7x
1710-910	White Cover	38	10x

## ■ Pendant

### 2136 Pendant Magnifiers

Pendant magnifiers are the ideal inconspicuous magnifier for those that need a little extra help throughout the day. Attractive and always at-hand, they feature glass lenses to resist scratching from contact with buttons, zippers or other jewelry.

Mounts, handle and chain of gold-plated or chrome-plated metal.

#### Technical Information:

**Magnification:** 3.5x (10D)

**Lens:** Biconvex, glass

**Len size:** 40 mm

**Mount:** Gold-plated or chrome-plated

**Chain Length:** Approximately 32"

Product #	Color	Dpt.	Magnification
2136-1	Gold-plated	10	3.5x
2136-2	Chrome-plated	10	3.5x

## System Vario Plus

The standard of care in low vision for over 20 years, ESCHENBACH System Vario Plus provides a high degree of flexibility in assessing and meeting the needs of the visually impaired.

The systematic structure with 9 different magnifications from 2.8x to 12.5x and 5 different illumination options can be combined in a highly flexible manner to provide 45 different illuminated magnifier combinations - completely individualized, as required.

This makes the System Vario Plus the illuminated magnification system with the most comprehensive choice of illuminations and magnifications.

ESCHENBACH has been providing the System Vario Plus with the proven XENON light for more than 10 years. The XENON gas in the light source sheds a continuous bright and clear light onto the reading matter and its reliability and brilliant quality of light mean that it has been adopted for a variety of uses in other fields, e.g., in the lighting technology of leading German car manufacturers.

More recently, ESCHENBACH has added LED (light-emitting diode) illumination to its System Vario Plus line in both battery and electric plug-in options. LEDs provide much brighter illumination than either incandescent or xenon options and never need to be replaced as they last as long as 10,000 hours. And, because LEDs use less energy than bulbs, batteries don't need to be changed as often.

### Application:

- Illuminated stand magnifiers are primarily for use at home.
- The System Vario Plus is particularly suitable for users who cannot hold the magnifying device steady (e.g., shaking due to age or Parkinson's).
- As the magnifiers rest on the reading material when used and do not need to be held freely in the hand, they are most suitable for reading over long periods of time.
- To achieve a uniform reading distance, System Vario Plus magnifiers should be used in combination with a reading stand (C-500 or 1605, see page 55).

### Characteristics:

- Large, non-slip light switches in a contrasting color make identification and use easier.
- The light-colored material and the closed magnifier body guarantee optimum illumination of the reading material.
- Magnifier tops with a diameter greater than 58 mm are fitted with a retractable, red reading line for improved line-by-line reading and improved readability.
- All rectangular magnifier tops are fitted with an extra retractable, segment-shaped 4 diopter lens.
- All Eschenbach illuminated stand magnifiers are calculated for a uniform adjusting distance (aE) of 400 mm (approximately 2.50D of accommodation).
- Magnification/dioptic value and the ideal eye-to-lens distance are stated on all magnifier heads.
- A height-adjustable adapter integrated into all handles makes it possible to adapt the height to the magnifier body used.
- 5 different handles available for appropriate selection of the most suitable illumination.

Incandescent (battery)

1599-10



Halogen (electric)

1599-304



LED (battery)

1599-40



LED (electric)

1599-6004



Halogen (battery)

1591-704



1557-73



1550-73



1551-73



1552-73



1553-93



1554-93



1559-93



1580-63



1583-63



For Ease of Use ratings, see pp. 16-17

# Stand Magnifiers

■ Illuminated



## System Vario Plus

1580-63

1



  
cera-tec®  
coating

1582-63

1



### Technical data

- All lenses are made of lightweight aspherical PXM®
- All lenses are hard-coated on both sides with cera-tec® coating
- The rectangular lens heads are fitted with an additional lens which can be pivoted in order to read small print or provide orientation on the reading material. Additional lens magnification: 4.0 dpt.
- All rectangular illuminated magnifiers offer tiltability for the most comfortable reading angle.

### 1580-63 (Magnification head only)

**Magnification:** 3x (7.6D)

**Lens Size:** 100x50 mm

**Lens:** Aspheric PXM® lightweight lens w/ cera-tec® coating

**Case:** Optionally available, 1560-3

### 1582-63 (Magnification head only)

**Magnification:** 2.8x (7D)

**Lens Size:** 100x75 mm

**Lens:** Aspheric PXM® lightweight lens w/ cera-tec® coating

**Case:** Optionally available, 1560-3

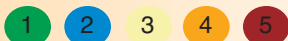

1=easy - 5=requires training

# System Vario Plus

All System Vario Plus heads and handles are ordered separately. See page 18 for handle choice.

## 1557-73 (Magnification head only)

**Magnification:** 12.5x (50D)

**Lens Size:** 35 mm

**Lens:** Aspheric PXM® lightweight lens w/cera-tec® coating

**Case:** Optionally available, 1560-xx (contact Customer Service for correct size)

## 1550-73 (Magnification head only)

**Magnification:** 10x (38D)

**Lens Size:** 35 mm

**Lens:** Aspheric PXM® lightweight lens w/cera-tec® coating

**Case:** Optionally available, 1560-xx (contact Customer Service for correct size)

**Note:** Attachable scale (divisions 1/5 mm and 1/64 inch)

## 1551-73 (Magnification head only)

**Magnification:** 7x (28D)

**Lens Size:** 35 mm

**Lens:** Aspheric PXM® lightweight lens w/cera-tec® coating

**Case:** Optionally available, 1560-xx (contact Customer Service for correct size)

## 1552-73 (Magnification head only)

**Magnification:** 6x (24D)

**Lens Size:** 50 mm

**Lens:** Aspheric PXM® lightweight lens w/cera-tec® coating

**Case:** Optionally available, 1560-xx (contact Customer Service for correct size)

## 1553-93 (Magnification head only)

**Magnification:** 5x (20D)

**Lens Size:** 60 mm

**Lens:** Aspheric PXM® lightweight lens w/cera-tec® coating

**Case:** Optionally available, 1560-xx (contact Customer Service for correct size)

## 1554-93 (Magnification head only)

**Magnification:** 4x (16D)

**Lens Size:** 70 mm

**Lens:** Aspheric PXM® lightweight lens w/cera-tec® coating

**Case:** Optionally available, 1560-xx (contact Customer Service for correct size)

## 1559-93 (Magnification head only)

**Magnification:** 3x (12D)

**Lens Size:** 80 mm

**Lens:** Aspheric PXM® lightweight lens w/cera-tec® coating

**Case:** Optionally available, 1560-xx (contact Customer Service for correct size)

## 18283 Diagnostic tray of illuminated stand magnifiers

This tray contains a complete assortment of our best selling magnifiers.

Contents: 12 pieces

1550-73, 1551-73, 1552-73, 1553-93, 1554-93, 1557-73, 1559-93, 1580-63, 1599-10, 1599-304, 1599-40, 1591-704. Tray-insert 18283-304 included at no charge with purchase of assortment.

Optionally available: 1880 white display tray with 1883-2 acrylic cover.

See technical data regarding ESCHENBACH Stand Magnifiers on page 61.

# Stand Magnifiers

■ Illuminated



1557-73

4



1550-73

3



1551-73

3



1552-73

2



1553-93

2



1554-93

2



1559-93

1



18283

# Stand Magnifiers

■ Illuminated

1599-10



1599-304



1599-40



1591-704

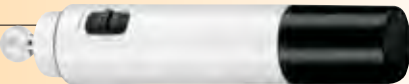

1599-604



1542

1543

1544



1545

1546



1560-3

1560-2

1560-1

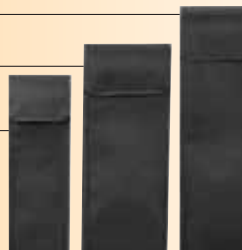

## 1599-10

This incandescent battery handle can be used with any Eschenbach magnification head.

**Illumination:** Incandescent

**Batteries:** Two "C" batteries, not included. Rechargeable batteries may be used.

**Bulb:** 1545 bulb. One bulb included. (2.5 volt, 250mA)

**Please note:** The 1599-10 handle opens from the base to change batteries.

## 1599-304

Halogen electric handle. Can be used with any Eschenbach magnification head.

**Illumination:** Halogen

**Power:** UL listed transformer

**Bulb:** 1546 bulb. One bulb Included. (4.0 volt, 550mA)

## 1599-40

LED battery handle can be used with any Eschenbach magnification head. Our most energy efficient. Yellow LED filters included.

**Illumination:** LED

**Batteries:** Two "C" batteries, not included. Rechargeable batteries may be used.

**Bulb:** 2 white LEDs, 122 mA, no replacement necessary.

**Please note:** Yellow filters included for the LEDs to allow for alteration of light color, if necessary. The 1599-40 opens from the base to change batteries.

## 1591-704

Halogen battery handle can be used with any Eschenbach magnification head.

**Illumination:** Halogen bulb

**Power:** Three "C" batteries. Not included. Rechargeable batteries may be used.

**Bulb:** 1546 bulb. One bulb included. (4.0 volt, 550mA)

**Please note:** The 1591-704 opens from the top to change batteries.

## 1599-6004

Electric LED handle can be used with any Eschenbach magnification head. Comes with yellow filters for the LEDs. A switch above the LEDs boosts the illumination by 33% when engaged.

**Illumination:** LED

**Power:** UL listed transformer

**Bulb:** 3 white LEDs, 122 mA, no replacement necessary.

## Replacement Bulbs

**1542 Bulb** (comes in a package with 2 bulbs)

Incandescent bulb, 2.5 Volt, 250 mA, E 10

Use with: 1585-04

**1543 Bulb** (comes in a package with 5 bulbs)

Incandescent bulb, 2.5 Volt, 250 mA, E 10

Use with: 1571, 1572, 1573, 1575

**1544 Bulb** (comes in a package with 2 bulbs)

Incandescent bulb, 2.5 Volt, 250 mA, E 10

Use with: 1510-2, 1510-3, 1510-41, 1510-5, 1510-7, 1510-10, 1510-12.

**1545 Bulb** (comes in a package with 5 bulbs)

Incandescent bulb, 2.5 Volt, 250 mA

Use with: 1599-10 handle

**1546 Bulb** (comes in a package with 2 bulbs)

Halogen bulb, 4.0 Volt, 550 mA

Use with: 1599-304 and 1591-704 handles

## System Vario Plus Cases

These cases are perfect for storing both the magnifier lens head and handle and are made of durable, sturdy nylon. They feature a soft, flannel-like lining on the inside to prevent scratches on the lens. The Velcro closure tab will seal the case tightly and let the magnifier rest securely. The cases come in three sizes (small, medium and large) to accommodate every combination of lens head and handle in our System Vario Plus product line. Contact our Customer Service Department at (800) 487-5389 for assistance in selecting the correct case.



1=easy - 5=requires training

# Highlighter

## Stand Magnifiers

■ Illuminated/Non-Illuminated

### 1585-04 Highlighter Stand Magnifier

**Special Features:**

Do you have patients that lose their place while reading because they can't stay focused on one line of text? Eschenbach's Highlighter features a unique design that sheds extra illumination on one line of text in the center of the lens, allowing your patients to easily stay on track!

Patients can also adjust the amount of illumination with a simple turn of the rheostat, so the amount of light will suit individual preferences perfectly. Along with a tilttable head that prevents overhead lighting glare, the magnifier handle contains a built-in stabilizer leg, so moving it across printed materials will be smooth and effortless.

**Technical Information:**

**Magnification:** 3.9x

**Diopters:** 11.4D

**Lens Type:** Tilttable aspheric PXM® lens is lightweight and features protective, scratch-resistant cera-tec® coating

**Lens Size:** 100 x 50 mm

**Illumination:** Halogen bulb – lasts about 100 hours [product #1542]



1585-04

1



*"I can solve crossword puzzles again!"*

# Viso-lux

### Rectangular Stand Magnifiers

The rectangular, large field lens of the 2636's is ideal for reading and writing.

**Special Features:**

- Aspheric PXM® lightweight lens with cera-tec® coating
- Open base for handwriting
- Lens rotates 180 degrees
- Transparent plastic base for clear, bright viewing

Note: 2636-11 features a 7D aspheric lens with "snap-on" 4D lens attached underneath. The 4D "snap-on" lens can be easily removed for greater working space for tasks such as handwriting.

Product #	Lens Size (mm)	Dpt.	Magnification
2636-7*	100 x 75	7	2.8x
2636-11	100 x 75	11	3.8x

\* Can be used with 1604-104 Bar Light. See page 54.



2636-7

1



2636-11

1



# Stand Magnifiers

■ Bar & Bright Field

2605

1



2606

1



2608

1



*"Really cool, what a magnifier!"*

1420

1



1421

1



1423-1

2



1424

1



## Bar Magnifiers

### Bar Magnifiers

Bar magnifiers provide shadow-free viewing for reading over long periods of time. Special red line guide on the 2606 and 2608.

#### 2605 Technical Information:

**Magnification:** 1.8x (cylindrical magnification)

**Lens:** Plastic

**Size:** 200 x 25 mm

**Note:** Black leather case available, model no. 2601-201 (not illustrated)

#### 2606

##### Special Features

The 2606 offers 2x magnification which is the highest magnification now available in a bar magnifier. This pocket bar magnifier was designed to be used with the 2636 stand magnifier to increase magnification by 2x.

##### Technical Information:

**Magnification:** 2x (cylindrical magnification)

**Lens:** PXM® material with an aspheric surface

**Size:** 122 x 26 mm

**Note:** Has red line guide.

#### 2608

##### Technical Information:

**Magnification:** 1.8x (cylindrical magnification)

**Lens:** Plastic

**Size:** 250 x 35 mm

**Note:** Has red line guide.

## Bright Field Magnifiers

### Bright Field Magnifiers

Inconspicuous - a magnifier that looks like a paper weight! Bright field magnifiers are very popular with children and executives. They provide distortion-free magnification simply by placing the magnifier on the reading material.

##### Special Features

Bright field magnifiers have a calculated light guidance that directs all possible illumination onto the object. This provides a brighter field of view without an additional light source.

#### 1420

##### Technical Information:

**Magnification:** 1.8x

**Lens:** Optical quality glass

**Rim:** Matte edge

**Size:** 65 mm

#### 1421

##### Technical Information:

**Magnification:** 1.8x

**Lens:** Optical quality glass

**Rim:** Black, threaded plastic

**Size:** 65 mm

**Note:** Black, plastic mount for easier gripping, orientation line

#### 1423-1

##### Technical Information:

**Magnification:** 1.9x

**Illumination:** 1 LED

**Lens:** PXM® lightweight material

**Rim:** Silver, plastic

**Size:** 35 mm

#### 1424

##### Technical Information:

**Magnification:** 1.8x

**Lens:** PXM® lightweight material with cera-tec® coating

**Rim:** Black, threaded plastic

**Size:** 45 mm

# Stand Magnifiers

■ Bright Field

## Makro-plus

### 1426/1436 Makro-plus aspheric

#### Special Features:

The 1426 and 1436 combine the light gathering advantages of the bright field magnifier with the optical benefits of an aspheric lens. Manufactured from PXM®, the 1426 and 1436 are a lightweight option to our glass bright field magnifiers. The plano base is raised 1 mm off the reading surface by ridges to prevent scratches.

#### 1426 and 1436

#### Technical Information

**Magnification:** 1.8x and 2.2x respectively

**Lens:** PXM® lightweight material

**Rim:** Matte edge

**Size:** 1426: 65 x 36 x 46 mm 1436: 90 x 35 x 70mm

**Note:** 1436 model is wide enough to span a column of newspaper.

## Makrolux

#### Special Features:

Features bright SMD LED illumination. The rectangular viewing area is the same size as a typical newspaper or magazine column. The lens is ergonomically tilted for comfortable reading with less fatigue.

#### 1436-1 Makrolux 2.2x

#### Technical Information:

**Magnification:** 2.2x

**Lens:** PXM® material with cera-tec® scratch resistant coating

**Rim:** Matte edge

**Size:** 90 x 35 x 70 mm

**Note:** Includes a soft micro-fiber bag to protect lens & 3 AA batteries.

#### 1436-2 Makrolux 3.6x

#### Technical Information:

**Magnification:** 3.6x

**Lens:** PXM® material with cera-tec® scratch resistant coating

**Rim:** Matte edge

**Size:** 90 x 35 x 70 mm

**Note:** Includes a soft micro-fiber bag to protect lens & 3 AA batteries.

#### 1436-1907 Makrolux Display

This sturdy point-of-purchase display shows a page of stock quotes onto which the Makrolux can be placed to show how the page is enlarged. Available free with the purchase of 3 Makrolux.

## Art of Optics

#### Art of Optics

A limited design edition of three magnifying lenses in the shape of animals. Perfect for an executive desk or display at home. Lightweight, flawless high-tech materials, magnifies 2x. Ideal for tasks such as reading maps or text.

#### 1460-1 The Dolphin (Hand-held magnifier)

#### 1460-2 The Hippo (Bright-field magnifier)

#### 1460-3 The Tortoise (Stand magnifier)

#### 1460-9 Art of Optics Display

For those who wish to combine an interest in beauty with a high degree of optical usefulness. Illuminated pedestals hold one of each animal. Decorative backscreen. FREE with purchase of 3 animals.



1426

1



1436

1



1436-1

1



1436-2

1



1436-19



1460-1

1



1460-2

1



1460-3

1



1460-9



1=easy - 5=requires training

# Stand Magnifiers

■ Bright Field/Lamp Magnifiers

1565-1

1



1565-1907



  
cera-tec®  
coating

2771-104

1

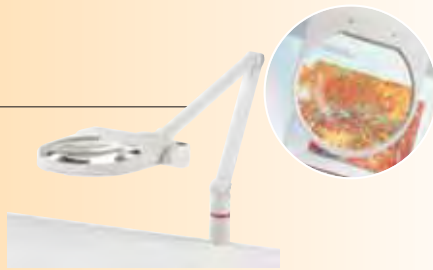

  
cera-tec®  
coating

2772-204

1



2772-02



2772-9



## ■ Scribolux

### 1565-1 Scribolux

The Scribolux features new, brighter SMD LEDs and is perfect for writing short notes, signing checks, doing crossword puzzles, changing hearing aid or watch batteries, or for any task that requires both hands to be free.

**Technical Information:**

**Magnification:** 2.8x (7D)

**Lens:** Aspheric PXM® lightweight lens w/ cera-tec® coating

**Size:** 100 x 75 mm

**Note:** Includes a soft micro-fiber bag to protect lens. 3 AA batteries are included.

### 1565-1907 Scribolux Display

This handy point-of-purchase display shows a crossword puzzle onto which the Scribolux can be placed to show how the puzzle is enlarged and how one can easily write under the lens. Available free with the purchase of 3 Scribolux.

## ■ Vario-maxi

### 2771-104

The Vario-maxi magnifying lamp features the largest lens in the world! It is ideal for reading as it provides a page-size field of view for any task requiring a long working distance and wide field.

**Special Features:**

This lamp magnifier is ideal for hobbywork and at 220 mm (9") in diameter, it is the largest lens available. The flexible head swivels 90° vertically and radially, and the system provides generous working distances.

**Magnification:** 1.75x (3D)

**Lens:** Aspheric with cera-tec® coating

**Lens Size:** 220 mm

**Arm:** Sturdy, articulated arm provides 36" of working radius

**Illumination:** 11 watt fluorescent lamp included (#2771-841)

**Note:** Cord is approximately 6 ft. long. Clamp attaches to tables from .75 to 3 inches in thickness. Operating radius at lamp approximately 36 inches.

## ■ Vario

### 2772

**Special Features:**

This lamp magnifier is ideal for hobbywork. The flexible head swivels 45° horizontally and 90° vertically and radially.

### 2772-204

**Magnification:** 3.8x (7.1D) (2-lens system)

**Lens:** Aspheric with cera-tec® coating

**Lens Size:** 132 mm

**Arm:** Sturdy, articulated arm provides 36" of working radius

**Illumination:** 9 watt fluorescent lamp included (#2772-840)

**Note:** Cord is approximately 6 ft. long. Clamp attaches to tables up to 3 inches in thickness. Dust cover included.

### 2772-02

Clear lens protector slides under the lens to protect the underside of the magnifier. Can be used on the 2772-204. Supplied in a pack of 3.

**Accessories:**

Table stand **2772-9** for 2772-204. Cast iron, weight: 13 pounds

# Stand Magnifiers

## Gooseneck/Around the Neck

### Gooseneck Magnifier

Designed for vision tasks that require both hands to be free, gooseneck magnifiers are suitable for personal tasks such as removing a splinter, or for industrial tasks such as examining or assembling small components.

#### 2774 Table Top Gooseneck Magnifier

**Technical Information:**

**Magnification:** 2x (2.6 D)

**Lens:** Bi-aspheric PXM® lightweight lens with Duplex coating

**Lens Size:** 140 x 100 mm

**Arm:** Gooseneck, flexible arm

**Base:** Sturdy, weighted, round table base

**Lens options:** Comes complete with lens 2782-01.

Can also be used with 2779-01 (2.8x), and 2778-01 (2x).

**Note:** When used with the 2778-01 magnifier, the 1604-104 Bar Light can be attached (see page 54).

**Lens Choice:**

Product #	Magnification	Lens	Lens Size
2778-01	2x (3.2 D)	Biconvex	120 mm
2779-01	2.8x (7D)	Aspheric	75 x 100 mm
2782-01	2x (2.6 D)	Bi-aspheric	140 x 100 mm

#### 2678 Around-the-Neck Magnifier

Perfect for tasks that require both hands to be free, such as with sewing, knitting or other work and hobbies.

**Special Features:**

- Bi-aspheric lens for near distortion-free viewing
- 4x (12D) bifocal lens (35 mm)
- Large field of view
- Transparent mounting for shadow-free viewing
- Adjustable cord to raise or lower height
- Rubber pads in feet to prevent slipping

**Technical Information:**

**Magnification:** 2x (2.6D) with 4x (12D) bifocal

**Lens:** Bi-aspheric (PXM® lightweight lens with Duplex coating)

**Bifocal Lens:** Bi-aspheric

**Lens Size:** 140 x 100 mm

**Bifocal lens size:** 35 mm

**Mount:** Transparent PXM®

**Note:** Comes complete with cord. Can be used with 1604-104 LED Bar Light when additional illumination is needed (see photo at right).

#### 2677 Economy Around-the-Neck Magnifier

Also ideal for hands-free tasks such as sewing, knitting and other work and hobbies.

**Special features:**

- The cord supplied with the magnifier makes it possible to adjust the height to individual requirements
- Transparent mounting for shadow-free viewing

**Technical Information:**

**Magnification:** 2x (3.2D)

**Lens:** Biconvex PXM®

**Lens Size:** 100 mm

**Mount:** Transparent PXM®

**Note:** Comes complete with cord



2774



2778-01



2779-01



2782-01



2678



2678 + 1604-104



2677



# Reading Glasses

Readers, Lorgnettes

2910-10  
2910-15  
2910-20  
2910-25  
2910-30  
2910-35  
2910-40



1

2910-01



2916-1xx

1



2916-2xx

1



2916-907

2918-1xx

1



2918-2xx

1



2918-907



## Mini-Frame Reading Glasses

### 2910

#### Mini-Frame Reading Glasses

Lightweight and attractive, these rimless glasses provide near magnification for reading and other close work.

#### Technical Information:

**Lens:** Transparent PXM® with surface coating

**Frame:** Chrome-plated

**Case:** Black leatherette

Product #	Diopter	Product #	Diopter
2910-10	+1.00	2910-30	+3.00
2910-15	+1.50	2910-35	+3.50
2910-20	+2.00	2910-40	+4.00
2910-25	+2.50		

### 2910-01 Mini-Frame Display

Attractive counter-top unit displays 10 pairs of Mini-Frame reading glasses with room to store the remainder in back. Free with purchase of any 25 pair.

### 2916

#### Clip & Read

The Clip & Read is a miniature pair of reading glasses that attaches to any portable device (such as a cell phone, laptop, or car visor) for extra magnification anywhere you need it. Available in gray and red. Includes case.

Product #	Diopter	Color
2916-115	+1.50	Red
2916-125	+2.50	Red
2916-215	+1.50	Gray
2916-225	+2.50	Gray

### 2916-907 Clip & Read Display

Attractive counter-top unit displays 12 pairs of Clip & Reads, in all diopters and both colors. Display is free w/ purchase of 12 Clip & Reads.

### 2918

#### Ready 2 Read

The Ready 2 Read is a lightweight, portable lorgnette. Perfect for reading labels, prescription bottles, train schedules, product ingredients, or menus. Available in black and designer styles. Protective case attached.

Product #	Diopter	Color
2918-115	+1.50	Black
2918-125	+2.50	Black
2918-215	+1.50	Designer
2918-225	+2.50	Designer

### 2918-907 Ready 2 Read Display

Attractive counter-top display contains 12 pairs of Ready 2 Reads, in all diopters and designs. Display is free w/ purchase of 12 Ready 2 Reads.



1=easy - 5=requires training

# Spectacle Magnifiers

## Head band and Clip-on Systems

### Headband Magnifier

#### 1648

##### Headband Magnifier

Ratcheted hinge on lens cover can be raised or lowered as needed. Interchangeable lenses snap into high grade plastic housing. Headband has adjustable strap and foam lining for greater comfort and ease of fitting.

##### Technical data:

**Frame:** Black ABS plastic with elastic headband

**Mount:** PXM lightweight lens with cera-tec® coating

Product #	Dpt.	Magnification	Working Distance (mm)	Replacement Lens
1648-17	2.5	1.7x	400	1645-5
1648-20	2.5	2x	250	1645-1
1648-25	5.0	2.5x	180	1645-2
1648-30	7.75	3x	160	1645-3



1648-17  
1648-20  
1648-25  
1648-30

1



1644-504  
w/lens

1



### Frame for Clip-on lenses

#### 1644-504 Frame for clip-on lenses

##### Special features:

- Can be comfortably worn over eyewear
- Discreet, black carrier mounting
- Lightweight
- Unrestricted field of view
- Lens positioning can be easily adjusted using quick snap closure

##### Technical data:

**Frame:** Metal frame, matte black finish

**Mount:** Lens clip element made of glass fiber-reinforced plastic. Order 1644-504 along with one of the 1645 lenses below.

### Clip-on Systems

#### 1646 Clip-on lens System

##### Special Features:

Clip-on magnifiers are designed to provide spectacle wearers with hands-free magnification.

- Hands-free
- Fits most eyeglass frames (Bridge: 25 mm, Jaws open 15 mm)
- Lightweight
- Lens is set 2 inches from eye, allowing for a more comfortable working distance
- When not needed, the lens can be flipped up and out of the way
- Lenses are interchangeable for different magnification needs (See order numbers below)

##### Technical Information:

**Lens:** PXM® lightweight lenses with cera-tec® coating

**Clip:** Glass fiber-reinforced plastic

**Note:** Four rubber tips for the clamps are included to protect the wearer's spectacle lenses.

Lens w/ Clip	Lens Only	Dpt.	Magnification	Working Dist. (mm)	Lens Type
1646-17	1645-5	2.5	1.7x	400	Binocular
1646-20	1645-1	2.5	2x	250	Binocular
1646-25	1645-2	5.0	2.5x	180	Binocular
1646-30	1645-3	7.75	3x	160	Binocular
1646-40	1645-4	16	4x	55	Monocular
1646-70	1645-7	28	7x	32	Monocular



1646-17  
1646-20  
1646-25  
1616-30

1



1646-40  
1646-70

2

3



1645-1, -2,  
-3, -4, -5

1



1645-4  
1645-7

2

3



1647

#### 1647 Diagnostic Kit

Designed to provide the eye care professional with a complete set of binocular and monocular clip-on lenses and two different lens mounting mechanisms.

##### Contents:

1644-C (display box), 1644-504, 1645-5, 1645-1, 1645-2, 1645-3, 1645-4, 1645-7, 1646-20.

# Spectacle Magnifiers

■ noves Magnifying Eyewear



**cera-tec®**  
coating



*"No one knows that I wear magnifying spectacles."*

1681-3R  
1681-3L

2

1681-4R  
1681-4L  
1681-5R  
1681-5L

3



1681-6R  
1681-6L

4

1681-03R  
1681-03L

2



1681-04R  
1681-04L  
1681-05R  
1681-05L

3

1681-06R  
1681-06L

4

1681-1Kit



1697



## noves mono

Eschenbach has continued its tradition of innovation with the noves system, the first eyewear ever produced to feature diffractive optical structures to magnify the image for the user. Thanks to years of research and millions of dollars in investments, Eschenbach's noves lenses, at less than 5 mm in thickness, can provide the magnifying power of refractive lenses more than twice as thick and many times the weight. And noves lenses represent the first low vision eyewear that is truly subtle, yet attractive!

### noves mono – the "invisible" magnifier

#### Application:

- The new, monocular magnifying eyewear with ultra thin lenses
- The ideal system for monocular near correction
- The attractive and functional frame design means a high degree of acceptance when worn in public

#### Characteristics:

- Orientation above the eyewear is possible due to the half-eye design
- Very lightweight due to the design and the use of diffractive optics
- noves eyewear are designed to be discreet, helping to improve user compliance

#### Technical data:

- Aspheric lenses made of PXM® material with integrated, diffractive structures
- Lens hard-coated on both sides with cera-tec® coating
- Balance lens features frosted finish
- Lens thickness is only 4.5 mm
- The noves eyewear weighs only 20 grams
- Frame with spring hinges, adjustable temples, soft nose pads and easily adjustable nose pad arms
- Frame size 41 mm, bridge size 22 mm, temple length 150 mm
- noves eyewear comes in a robust, hardtop case
- Available in either gold or silver colored frames

Product # (Gold)	Product # (Silver)	Diopter	Magnification	Working distance	Optics
<b>1681-3R</b>	<b>1681-03R</b>	12	3x	83 mm	right
<b>1681-3L</b>	<b>1681-03L</b>	12	3x	83 mm	left
<b>1681-4R</b>	<b>1681-04R</b>	16	4x	65 mm	right
<b>1681-4L</b>	<b>1681-04L</b>	16	4x	65 mm	left
<b>1681-5R</b>	<b>1681-05R</b>	20	5x	50 mm	right
<b>1681-5L</b>	<b>1681-05L</b>	20	5x	50 mm	left
<b>1681-6R</b>	<b>1681-06R</b>	24	6x	42 mm	right
<b>1681-6L</b>	<b>1681-06L</b>	24	6x	42 mm	left

### 1681-1Kit

#### Dispensing Kit

Contents: 1 of each of 1681-3R, 1681-3L, 1681-4R, 1681-4L, 1681-5R, 1681-5L, 1681-6R, and 1681-6L. Comes in attractive metal display case.

### 1681-KitOU (not pictured)

A special 4-piece kit containing one each of +12, +16, +20 and +24 noves eyewear with lenses mounted OU. For diagnostic purposes only. Comes in attractive metal display case.

### 1697 Diagnostic tray of noves eyewear

Contents: 13 pieces  
1681-3-L, 1681-3-R, 1681-4-L, 1681-4-R, 1681-5-L, 1681-5-R, 1681-6-L, 1681-6-R, 1682-4, 1682-5, 1682-6, 1682-8, 1682-10.  
Tray insert 1697-73 included at no charge with purchase of assortment.

Optionally available:

1880 white display tray with 1882-2 acrylic cover

noves bino – the “invisible” readers

Application:

- New ultra-thin eyewear offering binocular magnification
- The attractive glasses and functional frame mean a high degree of acceptance when worn in public

Characteristics:

- Orientation above the eyewear is possible due to the half-eye design
- Very lightweight due to the design and the use of diffractive optics
- noves eyewear are designed to be discreet, helping to improve user compliance

Technical Data:

- Aspheric lenses made of PXM® material with integrated diffractive structures
- Lens thickness is only 4.5 mm
- noves bino eyewear weigh only 20 grams
- Frame offers spring hinges, adjustable temples, soft nosepads, and easily adjustable nosepad arms
- Frame size 41 mm, bridge size 22 mm, temple length 150 mm
- noves eyewear comes in a robust hardtop case

Product # (Gold)	Product # (Silver)	Diopter	Working Distance
1682-4	1682-04	4	250 mm
1682-5	1682-05	5	200 mm
1682-6	1682-06	6	165 mm
1682-8	1682-08	8	125 mm
1682-10	1682-010	10	100 mm

1682-2Kit

Contents: 1 of each of +4D, +5D, +6D, +8D, +10D.  
Comes in attractive metal display case.



1682-4  
1682-5  
1682-6

1

1682-8  
1682-10

2



1682-04  
1682-05  
1682-06

1

1682-08  
1682-010

2



1682-2KIT



*"Now I can order  
for myself again!"*

1 2 3 4 5  
1=easy - 5=requires training

# Spectacle Magnifiers

## ■ Prismatic Eyewear

B 1680-4  
B 1680-6

1



B 1680-8  
B 1680-10

2

B 2204-4  
B 2204-6

1



B 2204-8  
B 2204-10

2

B 2702-4  
B 2702-6

1



B 2702-8  
B 2702-10

2

### B 1680

#### Half-eye Prism Eyewear

When normal reading glasses are no longer adequate for binocular reading, these new half-eye prism eyewear are ideal. Available in four different powers, these eyewear are stylish and functional.

#### Special Feature:

- Anti-reflection coated lenses for maximum light transmission
- Attractive gold half-eye frame with spring hinges and soft nose pads
- Case included

#### Technical Information:

**Lens:** CR 39 with A/R coating

**Frame:** Plastic temple covers can slide off so temples can be cut to a shorter length, if desired.

**Note:** Eschenbach Half-eye Prism Eyewear are prescription correctable. Contact our Customer Service Department at 800-487-5389 for details.

Product #	Power	Frame Size (mm)	Bridge Size (mm)	Temple Size (mm)
<b>B 1680-4</b>	4D w/+6DΔ in	41	22	150
<b>B 1680-6</b>	6D w/+8DΔ in	41	22	150
<b>B 1680-8</b>	8D w/+10DΔ in	41	22	150
<b>B 1680-10</b>	10D w/+12DΔ in	41	22	150
<b>B 1680-Kit</b>	One each of the B 1680-4, -6, -8, -10			

### Premium Prism Eyewear

Premium Prism Eyewear are designed for your patients who require higher levels of magnification, but don't want the look of traditional prismatic half-eyes. The Premium Prism Eyewear include high-quality lenses in a fashionable frame.

#### Special Features:

- Larger field allows macular degeneration patients to use their peripheral vision
- Choice of two lightweight and stylish metal frames made by Eschenbach
- Adjustable nose pads and temples for greater comfort
- A/R coated lens for maximum light transmission
- Each pair comes with protective case

#### Technical Data:

**Lens:** Injection molded optical plastic with A/R coating

**Frame:** See dimensions below

**Note:** Eschenbach Premium Prism Eyewear are prescription correctable. Contact our Customer Service Department at 800-487-5389 for details.

Product #	Frame	Power
<b>B 2204-4</b>	Gold	+ 4D w/+ 6DΔ in
<b>B 2204-6</b>	Gold	+ 6D w/+ 8DΔ in
<b>B 2204-8</b>	Gold	+ 8D w/+ 10DΔ in
<b>B 2204-10</b>	Gold	+ 10D w/+ 12DΔ in
<b>B 2702-4</b>	Pewter	+ 4D w/+ 6DΔ in
<b>B 2702-6</b>	Pewter	+ 6D w/+ 8DΔ in
<b>B 2702-8</b>	Pewter	+ 8D w/+ 10DΔ in
<b>B 2702-10</b>	Pewter	+ 10D w/+ 12DΔ in

#### Frame Information:

Product #	Frame Size (mm)	Bridge Size (mm)	Temple Size (mm)
<b>B 2204 (Gold)</b>	47	20	140
<b>B 2702 (Pewter)</b>	46	20	145

### ■ Economy Plus

#### B 3000

##### Economy Plus Prism Eyewear

This fashionable eyewear is available in 5 powers. The nickel alloy frame is modern, uni-sex and can be worn as a half-eye or as full-field spectacles.

##### Special Features:

- Spring-hinge temple design can be cut to fit children's size
- Economical price
- Case included with each pair
- Optional foam-lined carrying case available for the 4 piece diagnostic kit (B 3001-Kit contains one each of the following powers: +4, +6, +8 and +10)

##### Technical Information:

**Lens:** CR-39 with scratch resistant coating

**Frame:** Nickel alloy – see dimensions below

Product #	Frame	Power
<b>B 3000-4</b>	Bronze	4D w/ 6DΔ in
<b>B 3000-6</b>	Bronze	6D w/ 8DΔ in
<b>B 3000-8</b>	Bronze	8D w/ 10DΔ in
<b>B 3000-10</b>	Bronze	10D w/ 12DΔ in
<b>B 3000-12</b>	Bronze	12D w/ 14DΔ in
<b>B 3001-Kit</b>	Bronze	One of each pair +4, +6, +8, +10

##### Frame Information:

	Frame Size (mm)	Bridge Size (mm)	Temple Size (mm)
<b>B 3000's</b>	42	18	145



**B 3000-4**

1

**B 3000-6**

1

**B 3000-8**

2

**B 3000-10**

2

**B 3000-12**

2

### ■ Microscopes

#### UniVision from Unilens®

The UniVision lens is a 22mm round, lightweight, high plus lens that forms a microscopic system when mounted on a spectacle lens. The simple adhesive application allows the eyecare professional to mount the lens directly onto the patient's spectacles in the office in a matter of seconds. The UniVision lens can be applied in any position and the lens power can be upgraded or downgraded as necessary.

Kit includes: 10 UniVision lenses: 6D, 8D, 10D, 12D, 16D, 20D, 24D, 28D, 32D, 36D; 1 applicator kit; 6 trial frame carriers: 8D, 10D, 12D, 16D, 20D, 24D; 1 suction cup.

Product #	Description	Contents
<b>UN-910-1002</b>	UniVision Kit	10 lenses, 6 trial frame lenses, 1 applicator kit
<b>UN-910-005</b>	Applicator Kit	3 Tape Rings, 1 suction cup, 1 Tape applicator
<b>UN-910-501</b>	Tape Rings	Package of 5
<b>UN-910-006 through UN-910-040</b>	Additional Lenses	Lens # 6, 8, 10, 12, 16, 20, 24, 28, 32, 36, 40



**UN-910-1002**

5

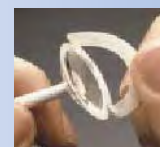

B64076

4



## ■ Spectacle Magnifiers with ClearImage II® Lenses

Eschenbach Spectacle Magnifiers offer Designs for Vision, Inc.'s ClearImage II® lenses in a fashionable, adjustable frame. These spectacle magnifiers are ideal for patients who wish to engage in extended viewing tasks requiring high magnification, especially with hands-free usage. They are also ideal for prismatic eyewear users who find they need to use a higher magnification due to the diminished acuities resulting from disease progression.

### Special Features:

- Distortion-free viewing from edge to edge
- Lightweight frame with wire bridge and temples
- Offered in a uni-sex frost colored frame
- Available in 7 powers from 8D to 32D

### Technical Information:

**Lens:** ClearImage II® lens (35 mm dia.) is made of hi-index glass with anti-reflection coating in a patented doublet lens design

**Frame:** See dimensions below

**Note:** All ClearImage II® Spectacle magnifiers from Eschenbach are prescription correctable. Contact our Customer Service Department at 800-487-5389 for details. For diagnostic purpose, OU versions can also be ordered. Please contact our Customer Service Department for more information.

### Spectacle Magnifiers

Frost Frame	Eye	Power
<b>B64076-08-OD</b>	Right	8D (2x)
<b>B64076-08-OS</b>	Left	8D (2x)
<b>B64076-12-OD</b>	Right	12D (3x)
<b>B64076-12-OS</b>	Left	12D (3x)
<b>B64076-16-OD</b>	Right	16D (4x)
<b>B64076-16-OS</b>	Left	16D (4x)
<b>B64076-20-OD</b>	Right	20D (5x)
<b>B64076-20-OS</b>	Left	20D (5x)
<b>B64076-24-OD</b>	Right	24D (6x)
<b>B64076-24-OS</b>	Left	24D (6x)
<b>B64076-28-OD</b>	Right	28D (7x)
<b>B64076-28-OS</b>	Left	28D (7x)
<b>B64076-32-OD</b>	Right	32D (8x)
<b>B64076-32-OS</b>	Left	32D (8x)

### Frame Information:

	Frame Size (mm)	Bridge Size (mm)	Temple Size (mm)
<b>B64076 (Frost)</b>	45	22	135

## Max Family of Galilean Systems

### Special Features:

These Galilean telescopes are hands-free, lightweight optical systems that offer a clear, bright, magnified image. These glasses are ideal for extended viewing tasks such as watching TV, sporting events, movies, theater, or for bird watching, reading or any other viewing activity in which a magnified image would be helpful.

### 1624-1 MaxTV (for distance)

#### Special Features:

- Flexible plastic temples
- Frosted objective lens housing eliminates distracting reflections
- Molded nose-bridge with no sharp edges

#### Technical Information:

**Magnification:** 2.1x

**Lens Size:** 32 mm

**Lens Material:** PXM® Plastic

**Lens Adjustment:** Each lens has a dial that allows it to adjust +/- 3D for spherical correction or to allow for a change in focal length

**Temple Length:** 135 mm

**Bridge:** Open saddle

**Frame Size:** 137 mm

**Focal Range:** 10 feet to infinity

**Visual Field:** 20 degrees

**PD Range:** 60 - 68 mm

**Weight:** 1.7 ounces or 49 grams

**Case:** Sturdy, protective, zippered case included

**Case Material:** Framed nylon with zipper



1624-1

1

### 1624-19 MaxTV Display

The MaxTV display, which holds 4 MaxTVs, is an attractive point-of-purchase display when placed on a counter top or small table in the waiting room or near the check-out desk. The display is free with the purchase of 4 MaxTVs (it is not available for purchase separately).



1624-19

### 1624-3 MaxEvent (for distance)

#### Special Features:

- Flexible plastic temples
- Frosted objective lens housing eliminates distracting reflections
- Molded nose-bridge with no sharp edges
- Tint filters out light below 390 nm
- Lenses feature mirror coating

#### Technical Information:

**Magnification:** 2.1x

**Lens Size:** 32 mm

**Lens Material:** PXM® Plastic with mirrored coating

**Lens Adjustment:** Each lens has a dial that allows it to adjust +/- 3D for spherical correction or to allow for a change in focal length

**Temple Length:** 135 mm

**Bridge:** Open saddle

**Frame Size:** 137 mm

**Focal Range:** 10 feet to infinity

**Visual Field:** 20 degrees

**PD Range:** 60 - 68 mm

**Weight:** 1.7 ounces or 49 grams

**Case:** Sturdy, protective, zippered case included

**Case Material:** Framed nylon with zipper



1624-3

1

### 1624-5 MaxDetail (for near)

#### Special Features:

- Flexible plastic temples
- Frosted objective lens housing eliminates distracting reflections
- Molded nose-bridge with no sharp edges

#### Technical Information:

**Magnification:** 2x

**Lens Size:** 32 mm

**Lens Material:** PXM® Plastic

**Lens Adjustment:** Each lens has a dial that allows it to adjust +/- 3D for spherical correction or to allow for a change in focal length

**Temple Length:** 135 mm

**Bridge:** Open saddle

**Frame Size:** 137 mm

**Working Distance:** 16 inches (may vary due to refractive error)

**Visual Field:** 20 degrees

**PD Range:** 60 - 68 mm

**Weight:** 1.7 ounces or 49 grams

**Case:** Sturdy, protective, zippered case included

**Case Material:** Framed nylon with zipper



1624-5

1

# Telescopes

Galilean



1636-2  
1636-3  
1636-4

4



1634  
1634-4

4

## Galilean Systems for Near

### Special Features

Eschenbach Galilean telescopes for near are small, lightweight optical systems that offer a bright image. They consist of a positive objective lens and a negative ocular lens, and are ideal for extended viewing tasks.

### 1636 Series

#### Binocular Galilean System for Near

##### Special Features:

- Unique adjustable frame allows the system to be used THAT DAY! No lab required!
- Adjustable bars for the pupillary distance can be locked in place simply by tightening the screws and using the included lockwasher
- Frame features cold bend wire-core temples (150 mm in length) and an adjustable saddle bridge

##### Technical Information:

**Magnification:** 2.5x, 3x, 4x (Spherical correction of +/- 5D)

**PD Range:** 54 to 74 mm

**Lens:** Achromatic objective, coated, 23 mm diameter

**Frame:** Black plastic, reinforced with fiberglass

**Weight:** 70 grams

**Case:** Simulated leather zippered case, included

**Rx:** Ocular side Rx can be added. Order 1622-1 for pattern and mounting tape. Contact our Customer Service Dept. at 800-487-5389 for custom Rx service.

Product #	Magnification	Field of View	Working Distance (mm)	Style
1636-2	2.5x	15.0°	75-350	Binocular
1636-3	3x	12.5°	45-200	Binocular
1636-4	4x	8.0°	35-250	Binocular

See page 62 for more technical information.

## Galilean Systems for Distance

### Special Features:

Eschenbach Galilean telescopes for distance feature small, lightweight optical systems that offer a bright image. They consist of a plus objective lens and a minus ocular lens. (See page 62 for more technical information.)

### 1634 Series

#### Binocular Galilean System for Distance

##### Special Features:

- Unique adjustable frame allows the system to be fitted immediately so it can be used THAT DAY! No lab required!
- Adjustable bars for pupillary distance can be locked by turning the screws
- Frame features cold bend wire-core temples (150 mm in length) and an adjustable saddle bridge which can be adjusted vertically for height as well as width

### 1634

##### Technical Information:

**Magnification:** 3x (Spherical correction of +/- 5D)

**Visual Field:** 160 m/1000 m\* (9.5°)

**Focus Range:** From 70 cm to infinity

**PD Range:** 54 to 74 mm

**Lens:** Achromatic objective, coated, 23 mm diameter

**Frame:** Black plastic, reinforced with fiberglass

**Weight:** 70 grams

**Case:** Simulated leather zippered case, included

**Rx:** Ocular side Rx can be added. Order 1622-1 for pattern and mounting tape. Contact Customer Service Dept. 800-487-5389 for Rx service.

### 1634-4

##### Technical Information:

**Magnification:** 4x (Spherical correction of +/- 5D)

**Visual Field:** 130 m/1000 m\* (7.5°)

**Focus Range:** From 78 cm to infinity

**PD Range:** 54 to 74 mm

**Lens:** 3-lens, multi-coated achromatic objective

**Frame:** Black plastic, reinforced with fiberglass

**Weight:** 70 grams

**Case:** Simulated leather zippered case, included

**Rx:** Ocular side Rx can be added. Order 1622-1 for pattern and mounting tape. Or contact our Customer Service Department at 800-487-5389 and ask about our convenient customer Rx service.

\*Figures for field of view are average values. Field will vary depending on the distance from the eye to the eyepiece.

## Rido-comfort/Tele-comfort

### 1638 and 1639 Series

These modern-looking telescopes are ideal for either near tasks like reading or for distance tasks like watching television or sporting events. Using new diffractive optics, they are very light and comfortable to wear. Their attractive silver/gray color also improves cosmesis.

#### Special Features:

- Lightweight (only 46 grams—33% less than comparable products)
- Modern design improves cosmesis
- PD can be adjusted using screws under bridge cover
- Open saddle bridge provides comfort
- Objective lens provides spherical correction of +/- 5D

### 1638

#### Binocular Galilean System for Near

##### Technical Information:

**Magnification:** 2.5x

**Field of View:** 12° (Figures for field of view are average values. Field will vary depending on the distance from the eye to the eyepiece.)

**Focus Range:** 250 mm

**PD Range:** 54 to 74 mm

**Lens:** Aspheric-diffractive lens design

**Frame:** Chromium-plated metal temples

**Housing:** Plastic reinforced with fiberglass

**Weight:** 46 grams

**Case:** Simulated leather zippered case, included

### 1639

#### Binocular Galilean System for Far

##### Technical Information:

**Magnification:** 2.5x

**Field of View:** 13° (Figures for field of view are average values. Field will vary depending on the distance from the eye to the eyepiece.)

**Focus Range:** 650 mm - ∞

**PD Range:** 54 to 74 mm

**Lens:** Aspheric-diffractive lens design

**Frame:** Chromium-plated metal temples

**Housing:** Plastic reinforced with fiberglass

**Weight:** 46 grams

**Case:** Simulated leather zippered case, included



"Whether near ...

... or far, this vision aid has become simply indispensable for me!"



1638

4



1639

4

## Mirage Telescopes

### Eschenbach Mirage Telescopes - BE-525, BE-730 and BE-731

Eschenbach offers the Mirage 5.5x and 7x telescopes in a binocular as well as a monocular design for patients who require high levels of magnification for extended distance viewing. Mirage telescopes provide superior optics via anti-reflective coated lenses, adjustable frames reinforced with fiber glass, and high-resolution mirrors. Each telescope can be focused from 6' to infinity, and each has a protective carrying case.

#### Technical Information:

##### BE-525 Telescopes:

**Magnification:** 5.5x

**Field of View:** 11°

**PD Range:** 54-64 mm and 50-74 mm

**Weight:** Monocular style: 2.5 oz.

Binocular style: 3.5 oz.

##### BE-730 and BE-731 Telescopes:

**Magnification:** 7x

**Field of View:** 9°

**PD Range:** 54-64 mm and 50-74 mm

**Weight:** Monocular style (BE-731): 3 oz. Binocular style (BE-730): 4.5 oz.



BE-525

BE-730

5



BE-525 OD

BE-525 OS

5

BE-731 OD

BE-731 OS

5



1623

4



- 1623-0
- 1623-3
- 1623-4
- 1623-5
- 1623-6
- 1623-8
- 1623-10
- 1623-12

4



1630

4



## Wide-field Galilean Telescope

### 1623 Wide-field Galilean Telescope

This monocular telescope is ideal for distance tasks like watching TV and for near tasks like reading, when used with a reading cap. Made with diffractive optics technology, the 1623 telescope provides an astounding 22 degrees field of view and does so at only 17 grams in weight making it an ideal mounted telescope.

#### Special Features:

- Very lightweight
- Large field of view
- Accommodates snap-on, hinged reading caps that can be flipped-up out of the way
- Designed for mounting (in spectacles or ESCHENBACH's adjustable 1631 frame - see pg. 40) or for use with a finger ring (see pg. 36).
- No focusing required
- Can be prescription corrected
- Aspherical PXM® lightweight lens, 42 mm in diameter
- Lens hard-coated on both sides with cera-tec®
- Reading caps are easy to handle; they can be folded up easily without having to be detached.

#### Technical information:

**Magnification:** 2x

**Degrees of Field:** 22°

**Housing:** Gray plastic

**Weight:** 18 grams (25 grams with reading cap)

#### Accessories:

##### Snap-on Reading Caps

- 1623-0** Frosted lens
- 1623-3** Attachment lens 3D
- 1623-4** Attachment lens 4D
- 1623-5** Attachment lens 5D
- 1623-6** Attachment lens 6D
- 1623-8** Attachment lens 8D
- 1623-10** Attachment lens 10D
- 1623-12** Attachment lens 12D
- 1623-01** Reading Cap Ring

Product #	Magnification	Working distance	Field of view*
<b>1623</b>	2.0x	∞	380m/100 mm
<b>1623 + 1623-3</b>	1.5x	330 mm	130 mm
<b>1623 + 1623-4</b>	2.0x	250 mm	100 mm
<b>1623 + 1623-5</b>	2.5x	200 mm	80 mm
<b>1623 + 1623-6</b>	3.0x	167 mm	66 mm
<b>1623 + 1623-8</b>	4.0x	120 mm	48 mm
<b>1623 + 1623-10</b>	5.0x	100 mm	40 mm
<b>1623 + 1623-12</b>	6.0x	83 mm	34 mm

\*Figures for field of view are average values. Field will vary depending on the distance from the eye to the eyepiece.

More technical data on page 62.

### 1630 Test Kit

With the contents of this kit, you can test most adjustments for far and near.

#### Contents:

- 2 x 1623 with trial frame rings attached
- 1 each x 1623-0, 1623-3, 1623-4, 1623-5, 1623-6, 1623-8, 1623-10, 1623-12



1=easy - 5=requires training

## Galilean 2.2x Afocal Telescope System

### Special Features:

- Lightweight and cosmetically appealing
- Reading caps allow for near vision tasks
- Designed for mounting (in spectacles or ESCHENBACH's adjustable 1631 frame - see pg. 40) or for use with a finger ring (see pg. 36).
- This modular-lenseatic system has been calculated and designed to largely eliminate chromatic aberration
- Can be prescription corrected

## 1621 Galilean Telescope

### Technical Information:

**Base Magnification:** 2.2x

**Visual Field:** 14°, 250 m/1000 m

**Housing:** Black plastic

**Weight:** 16 grams

**Rx:** Ocular side Rx can be added. Order 1622-1 for Rx carrier and mounting tape. Or contact our Customer Service Department at (800) 487-5389 and ask about our convenient customer Rx service.



1621

4

## Reading Caps for 1621, 1622-5 and 1673s\*

Product #	Power of Cap	Magnification with Cap	Field (1621) degrees	Working Distance (mm)
1621-0	Occluder			
1621-3	+3D	1.65x	12°	330
1621-4	+4D	2.2x	12°	250
1621-5	+5D	2.75x	12°	200
1621-6	+6D	3.3x	12°	167
1621-8	+8D	4.4x	12°	120
1621-10	+10D	5.5x	12°	100
1621-12	+12D	6.6x	12°	83
1621-16	+16D	8.8x	12°	63



1621-0  
1621-3  
1621-4  
1621-5  
1621-6  
1621-8  
1621-10  
1621-12  
1621-16

4

\*Note: 1673s require an adapter to use the reading caps. For the 1673-1 and 1673-2, use the 1673-02 adapter. For the 1673-3 and 1673-4, use the 1673-03 adapter (see page 36 for 1673s).

## 1622-5 Galilean Telescope

### Special Features:

This afocal Galilean Telescope adds a new higher power of 2.5x in our Galilean line and fills the gap between the 2.2x Galilean telescope and the 2.8x Keplerian telescope (1673-1). Not only does this telescope fill an unmet magnification need, but it does so using a Galilean design which allows the telescope to be light in weight, making it ideal for mounting into eyewear.

### Technical Information:

**Magnification:** 2.5x

**Field of View:** 13°

**Weight:** 11 grams

**Lens:** Hard, anti-reflective coating

**Mounting:** Can be mounted using Eschenbach's Telescope Mounting Service

**Miscellaneous:** Can be used for near tasks using 1621 reading caps (in powers of 3D to 16D).



1622-5

4

## 1510-25 Mobilux Far® – A telescope and magnifier in one!

### Technical Information:

**Magnification:** 2.5x when set as a telescope ("off" position), 3.2x when set as a hand-held magnifier ("on" position)

**Lens:** Diffractive lens hybrid made of PXM® material

**Illumination:** one LED

**Batteries:** 2 AA batteries (included)



1510-25

3

*"I have not been able to see information so quickly and so reliably for a long time."*

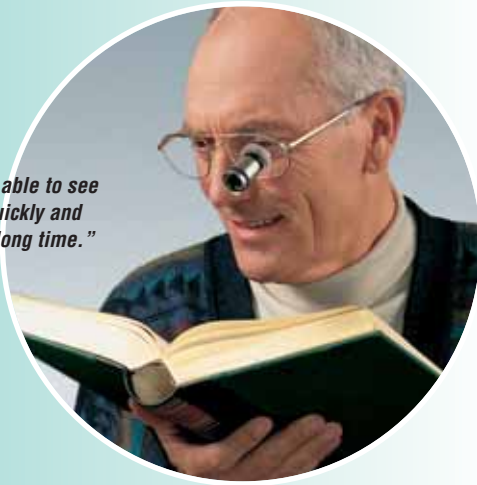

1673-1  
1673-2

3



1673-3  
1673-4

3



1673-02  
1673-03



1671-1

1



## 1673 Keplerian Telescopes

### 1673 Series - Keplerian Telescopes

#### Special Features:

The Keplerian series is unique in that the telescopes can be used in a variety of ways:

- Can be used for distance, intermediate and near use
- Unlimited working distances by simply adjusting the focus (from 20 cm to infinity)
- Can be used as a hand-held spotting telescope
- Can be easily mounted in the ESCHENBACH 1631 frame to do hands-free tasks (see page 40)
- Can be used with 1671-1 finger ring support (see below)
- Can be used with ESCHENBACH's reading caps using either the 1673-02 adapter (for 1673-1 and 1673-2) or the 1673-03 adapter (for 1673-3 and 1673-4)

#### Technical Information:

**Lens:** Achromatic glass lens, multi-coated, integrated miniature roof-prism

**Housing:** Brushed metal/rubber grip

**Rx:** Ocular-side Rx can be added. Order 1622-1 for Rx carrier and mounting tape

**Case:** Comes with soft black case with zipper closure and carrying cord

**Note:** Unscrew eyepiece to mount in 1631 frame or lens

Product #	Magnification	Visual Fields	Degrees of View	Objective Lens Diameter
<b>1673-1</b>	2.8 x Dist	220/1000 m	12.5°	9 mm
	3.4 x Near	26/150 mm	10°	
<b>1673-2</b>	4.2 x Dist.	175/1000 m	10°	10 mm
	5.5 x Near	25/200 mm	7.2°	
<b>1673-3</b>	4.2 x Dist.	220/1000 m	12.5°	12 mm
	5 x Near	32/200 mm	9.2°	
<b>1673-4</b>	6 x Dist.	175/1000 m	10°	16 mm
	7.6 x Near	26/250 mm	6.0°	

See page 62 for more technical information.

#### 1671-1 Finger Ring

The 1671-1 Finger Ring adds support for those who use the 1673 series frequently as a hand-held monocular. The 1673 monoculars mount on the Finger Ring in similar fashion to the 1631 frame above.



1=easy - 5=requires training

## 1632 Diagnostic Testing Kit

The 1632 kit is designed for diagnostic testing of visually impaired patients. The kit comes complete with trial frame adapters attached to the (2) 1621, and (1) 1622-5 telescopes for easy testing. Also included are reading caps to adapt the telescopes for near tasks.

### 1632 Contents:

- 1621** Galilean 2.2x (2 pcs.)
- 1622-5** Galilean 2.5x
- 1673-1** Keplerian monocular 2.8 x 9
- 1673-2** Keplerian monocular 4.2 x 10
- 1673-3** Keplerian monocular 4.2 x 12
- 1673-4** Keplerian monocular 6 x 16
- 1619** Trial frame adapters (6 pcs., of which 4 are fitted)
- 1671-1** Finger ring
- 1673-02** Adapter for 1673-1 and 1673-2
- 1673-03** Adapter for 1673-3 and 1673-4
- 1621-0** Clear lens
- 1621-3** Reading cap 3D
- 1621-4** Reading cap 4D
- 1621-5** Reading cap 5D
- 1621-6** Reading cap 6D
- 1621-8** Reading cap 8D
- 1621-10** Reading cap 10D
- 1621-12** Reading cap 12D
- 1621-16** Reading cap 16D



1632

## 1632-1 Galilean Diagnostic Kit

Same as the 1632 but without the Keplerian monoculars.

## 1632-2

Empty Diagnostic Kit.



1632-1

## 1696

### Diagnostic tray of Galilean, Keplerian and Clip-on Vision Aids

Contents: 17 Pieces

1510-25, 1624-1, 1624-5, 1631, 1634, 1634-4, 1644-504, 1646-70, 1645-1, 1645-2, 1645-3, 1645-4, 1645-5, 1671-1, 1673-1, 1673-2, 1673-3. Tray insert 1696-1304 included at no charge, with purchase of assortment.

Optionally available:

1880 white display tray with 1882 acrylic cover



1696

## Monocular Telescopes

1674-820

4



### Prism Monoculars 1674-820 and 1674-832

#### Special Features:

- First, as a hand-held telescope to detect details at a distance such as street names, house numbers, or road signs
- Second, as a hand-held microscope for close-up (short focus) viewing
- Third, as a stand microscope of up to 25x

#### 1674-820

##### Technical Information:

**Magnification as Telescope:** 8x

**Visual Field:** 125 m/1000 m, 7°

**Focus Range:** 30 cm to infinity

**Magnification as Microscope:** 25x

**Stand Magnifier Included:** 3x

**Lens:** Achromatic, multi-coated, roof prism system

**Lens Size:** 20 mm diameter

**Housing:** Light-metal

**Case:** Black leather protective case included

1674-832

4



#### 1674-832

##### Technical Information:

**Magnification as Telescope:** 8x

**Visual Field:** 140 m/1000 m, 8°

**Focus Range:** 70 cm to infinity

**Magnification as Microscope:** 25x

**Stand Magnifier Included:** 3x

**Lens:** Achromatic, multi-coated, roof prism system

**Lens Size:** 32 mm diameter

**Housing:** Light-metal

**Case:** Black leather protective case with belt loop included

4293-616

4293-816

3



### 4293 One-handed Slide Focus Telescopes

This innovative line of monocular Keplerian telescopes provides a unique panoramic field of view and is available in a choice of two different magnifications. All of the monocular telescopes feature the unique slide-focus mechanism designed for single-hand use. Case included.

#### Special Features:

- Simple slide-focus mechanism can be used with one hand
- Unique rectangular Keplerian design provides a panoramic field of view
- Rubber coated for protection and durability

#### Technical Information:

**Magnification:** 6 x 16, or 8 x 16

**Weight:** 64 grams

**Visual Field:** 8° or 7°

**Focus Range:** 1m to infinity

**Case:** Included

Product #	Magnification	Degrees of Field
4293-616	6x	8°
4293-816	8x	7°

4292-821

3



### 4292-821

#### Special Features:

- Unique Porro design
- Folds down to only 2 3/4" x 1 7/8" x 1"
- Porro design minimizes the effect of tremors on image
- Rugged exterior with rubberized, dimpled coating

#### Technical Information:

**Magnification:** 8 x 21

**Weight:** 73 grams

**Visual Field:** 6.4°

**Focus Range:** 1.5m to infinity

**Case:** Included

### 4294-413 Microlux 4x13

Designed for single-hand use, this monocular telescope is ideal for museums, sporting events and many other leisure activities. Squeeze the casing once and the Microlux expands for use. Squeeze it again and it retracts into its protective case. Additionally, if used in reverse, the Microlux acts as a field expander, ideal for those with restricted visual fields.

#### Special Features:

- Compact design--only 48 mm x 25 mm x 38 mm when closed
- Simple opening and closing mechanism allows for single-hand use
- Rubber exterior at the grip prevents slipping
- Fully coated optics offer a bright image

#### Technical Information:

**Magnification:** 4 x 13

**Weight:** 46 grams

**Visual Field:** 13°

**Focus Range:** 10 feet to infinity (fixed focus)

**Case:** Included

**Size-Open/Closed:** Length: approx. 2 in.; Width: approx. 1 in.; Height: 2 in. when opened, 1.25 in. when closed.



4294-413

2



### 4294-618 Microlux 6x18

#### Special Features:

Your patients will love the Microlux 6x18 for its easy use, compact size, and excellent functionality. The simple opening mechanism is designed for single-handed use, and the rubber exterior at gripping points ensures a secure, non-slip grasp. This monocular telescope is ideal for use at museums, sporting events, bird watching, or reading far away signs. It is portable, fits easily into a pocket or purse, and is especially convenient for low vision applications because it provides 6x magnification with a touch of the finger. When not in use, it easily slips back into its protective case.

#### Technical Information:

**Magnification:** 6 x 18

**Weight:** 78 grams

**Visual Field:** 8°

**Focus Range:** 10 feet to infinity (semi-focusable)

**Case:** Includes a carrying strap and lightweight carrying case.

**Size-Open/Closed:** Length: approx. 3 in.; Width: approx. 1 in.; Height: 2.4 in. when open, 1.6 in. when closed.



4294-618

3

### 8417-3822 Compact 8x Binoculars

This compact and lightweight pair of binoculars is ideal for low vision applications as well as sporting and recreational use. Features include multi-coated lenses, semi-internal focus, diopter adjustment, carrying case, and strap. Rubber eyepieces fold back for use by spectacle wearers.

#### Technical Information:

**Magnification:** 8 x 22

**Visual Field:** 142 m/1000 m, 8°

**Weight:** 203 grams



8417-3822

2

### 84158-8 Lightweight 8x Binoculars

This compact and lightweight pair of binoculars is ideal for low vision applications as well as sporting and recreational use. Features include multi-coated lenses, reverse Porro prisms, semi-internal focus, diopter adjustment, carrying case, and strap. Rubber eyepieces fold back for use by spectacle wearers.

#### Technical Information:

**Magnification:** 8 x 21

**Visual Field:** 123 m/1000 m, 7°

**Weight:** 168 grams



84158-8

2



1=easy - 5=requires training

1693-4916  
1693-5116  
1693-5218



## Carrier Systems

### 1693 Carrier Frame

#### Special Features:

This frame is designed for mounting Eschenbach's Galilean and Keplerian monocular telescopes. The unisex frame is made of titanium and nickel and has spring-hinged temples. The lens includes a grid that makes marking even easier. The frame is available in 3 sizes and includes a soft saddle bridge nose pad.

#### Frame Information:

Product#	Frame Size (mm)	Bridge Size (mm)	Temple Size (mm)
1693-4916	49	16	150
1693-5116	51	16	150
1693-5218	52	18	150

1631

4



### 1631 Frame

#### Special Features

Designed to offer more flexibility to users of the 1621, 1622-5, 1623, and the 1673 series of telescopes

- Allows users to easily mount their monocular telescope and use it as a hands-free vision aid
- Especially useful when watching TV or reading for extended periods of time
- Adjustable bridge, pupillary distance and temples allow for a perfect fit every time!

#### Technical Information:

**Frame:** Black, fiberglass-reinforced plastic

**PD Range:** 54 to 74 mm

**Bridge:** Adjustable plastic saddle bridge, adjusts vertically for height as well as width

**Temples:** Black plastic with wire core, cold bend temples, 150 mm in length

**Case:** Comes w/occluder, leather case and strap

**Weight:** 35 grams

#### Mounting a 1673 monocular into the 1631 frame

1. Turn the monocular so it is fully extended.
2. Give the monocular a firm turn to loosen the eyepiece, and unscrew the eyepiece from the monocular.
3. Fit monocular through the desired ring of the 1631 frame and screw on the eyepiece at the back of the frame or fasten with a 1671-5 lock washer.
4. Tighten eyepiece or washer completely before adjusting focus.



## Diagnostic Galilean Telescope Kit

### DVI-TSKit

Eschenbach partnered with Designs for Vision, Inc. (DVI) to create this diagnostic kit of customized Galilean telescopes and test frames. The kit includes 6 telescopes that have been specially designed to snap easily into one of the 4 available test frames. The kit can help you determine the optimum mounted telescope solution for your patients and demonstrate it to them without the hassle of trial frames! The kit includes:

- 3 Focusable DVI Spiral Galilean Telescopes in powers of 2.2x, 3x, and 4x
- 2 DVI Bioptic Telescopes (1 round, 1 rectangular, both 2.2x)
- 1 DVI Afocal Full Diameter Telescope (2.2x)
- 2 specially-adapted Eschenbach 1631 frames for full diameter testing
- 2 Nickel allergy-free titanium Eschenbach Frames (1693) pre-drilled for bioptic testing
- 2 Trial frame carriers
- 2 Sets of replacement springs

This Diagnostic Galilean Telescope kit is perfect for low vision practitioners who want to expand their practice into custom-mounted telescopic solutions for their patients. Bioptic combinations can be identified that assist low vision patients in viewing magnified distant objects while allowing them to use their spectacle prescription for near. The convenient “snap-in, snap-out” mechanisms allow you to quickly demonstrate to your patients the functionality and appearance of a custom mounted telescope before ordering!

**Note:** These telescopes can only be purchased with the spring-connect mechanism (to be used as part of the kit) or as a finished mounting job.

### DVI-TSKit Telescope Information

These telescopes feature the highest quality glass optics and are easy to fit in full-diameter or bioptic positioning due to their Galilean design. Once the optimal telescope is identified, you can then order this telescope. The kit includes:

#### DVI-2.2 BIO 1

2.2x Bioptic Galilean Telescope for Distance (Afocal)

**Magnification:** 2.2x

**Field of view:** 16 degrees

**Range of focus:** Infinity

#### DVI-2.2 BIO 2

2.2x Bioptic Galilean Telescope for Distance (Afocal)

**Magnification:** 2.2x

**Field of view:** 11 degrees

**Range of focus:** Infinity

#### DVI-2.2 FDTS

2.2x Full Diameter Galilean Telescope for Distance (Afocal)

**Magnification:** 2.2x

**Field of view:** 16 degrees

**Range of focus:** Infinity

#### DVI-2.2 SGTS

2.2x Spiral Galilean Telescope for Distance (Focusable)

**Magnification:** 2.2x

**Field of view:** 11 degrees

**Range of focus:** 12" to infinity

#### DVI-3.0 SGTS

3.0x Spiral Galilean Telescope for Distance (Focusable)

**Magnification:** 3.0x

**Field of view:** 8 degrees

**Range of focus:** 8" to infinity

#### DVI-4.0 SGTS

4.0x Spiral Galilean Telescope for Distance

**Magnification:** 4.0x

**Field of view:** 6 degrees

**Range of focus:** 8" to infinity

Contact Eschenbach at (800) 487-5389 to learn how to order a prescription corrected telescope system!



DVI-TSKit



1693 w/  
DVI-3.0  
SGTS



DVI-2.2 BIO1

5

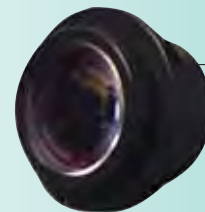

DVI-2.2 BIO2

5



DVI-2.2 FDTS

5



DVI-2.2 SGTS

5



DVI-3.0 SGTS

5



DVI-4.0 SGTS

5

# Absorptive Filters

■ Solar Shields®

Lg TAE24353  
Med TAE27102  
Sm TAE25353

1



Amber

Lg TAE24357  
Med TAE27103  
Sm TAE25357

1



Yellow

Lg TAE24150  
Med TAE27101  
Sm TAE25150

1



Gray

Lg TAE24354  
Med TAE27104  
Sm TAE25354

1



Orange

Lg TAE2435P  
Med TAE2735P  
Sm TAE2535P

1



Plum



## SolarShields®

### SolarShield® Contrast-Enhancing Absorptive Filters

Eschenbach carries an exclusive line of absorptive filters specifically for the low vision patient. These absorptive filters were developed in cooperation with Dioptrics Medical Products, the manufacturer of the #1 doctor recommended sunglass. SolarShields® provide 40% more protection from the sun than ordinary sunglasses because of the protective top and side shield design.

#### Features of SolarShield® Filters Include:

- 5 lens tints to choose from (gray, plum, yellow, amber, orange).
- Gray polarized and plum lenses decrease overall light transmission and reduce glare. Yellow, orange, and amber lenses decrease blue light transmission and increase contrast.
- 3 frame sizes: small, medium, and large. Small frames will fit patients who wear smaller eyewear or no eyewear at all. Medium and large sizes will comfortably fit over standard eyewear.
- All SolarShields® block 100% of UVA/UVB.
- Bend-to-fit temples provide a comfortable, custom fit
- Each pair of SolarShields® comes with a protective case
- Lenses can be replaced with Rx'd lenses, if needed

Product #	Size	Lens Tint nm Light Blocked	Light Trans- mitted
<b>TAE24357</b>	Large	Yellow - 450 nm	71%
<b>TAE24354</b>	Large	Orange - 525 nm	35%
<b>TAE2435P</b>	Large	Plum - 400 nm	15%
<b>TAE24353</b>	Large	Amber - 511 nm	35%
<b>TAE24150</b>	Large	Gray polarized - 380 nm	17%
<b>TAE27103</b>	Medium	Yellow - 450 nm	71%
<b>TAE27104</b>	Medium	Orange - 525 nm	35%
<b>TAE2735P</b>	Medium	Plum - 400 nm	15%
<b>TAE27102</b>	Medium	Amber - 511 nm	35%
<b>TAE27101</b>	Medium	Gray polarized - 380 nm	17%
<b>TAE25357</b>	Small	Yellow - 450 nm	71%
<b>TAE25354</b>	Small	Orange - 525 nm	35%
<b>TAE2535P</b>	Small	Plum - 400 nm	15%
<b>TAE25353</b>	Small	Amber - 511 nm	35%
<b>TAE25150</b>	Small	Gray polarized - 380 nm	17%

**TAE17P202D** SolarShield® Display - holds 20 SolarShields® or Solar 3s (see pg. 43). The display is free with the purchase of any 20 SolarShields® or Solar 3s.



# Absorptive Filters

## Solar 3s

### Solar 3s



#### Solar 3s Contrast-Enhancing Absorptive Filters

Solar 3 contrast-enhancing filters are wrap-around style glasses that are ideal for emmetropes, contact lens wearers, younger patients and fashion-conscious seniors. Available in five lens tints (amber, yellow, polarized gray, orange, and plum), Solar 3 filters are unisex, lightweight, and designed to reduce intraocular glare (gray) and improve contrast (other tints).

Unlike SolarShields®, Solar 3s are designed to be worn as 'wear-alones' as opposed to SolarShields® which fit over a patient's prescription eyewear.

#### Solar 3 Features Include:

- Lenses are manufactured with scratch-resistant polycarbonate materials.
- All Solar 3 filters block 100% of UVA/UVB.
- All frames are made of lightweight nylon-66.
- Solar 3 filters have bend-to-fit temples for a custom fit.
- The tinted lenses block visible light below the following wave lengths: gray and plum lenses (400 nm); yellow (450 nm); amber (511 nm); orange (525 nm).
- An attractive, rotating display is free with the purchase of 20 Solar 3s or SolarShields®.

Product #	Style	Lens Tint nm Light Blocked	Frame Size
<b>TAE6V355C5Y</b>	Unisex	Yellow - 450 nm	131 mm
<b>TAE6V355C52</b>	Unisex	Orange - 525 nm	131 mm
<b>TAE6V355C5P</b>	Unisex	Plum - 400 nm	131 mm
<b>TAE6V355C58</b>	Unisex	Amber - 511 nm	131 mm
<b>TAE6V3555S</b>	Unisex	Gray polarized - 380 nm	131 mm



Amber

TAE6V355C58



Yellow

TAE6V355C5Y



Gray

TAE6V3555S



Orange

TAE6V355C52



Plum

TAE6V355C5P



**TAE17P202D** Solar 3 Display - holds 20 Solar 3s. The display is free with the purchase of any 20 Solar 3s or SolarShields®.



TAE-17P202D

# Video Magnifiers

■ Portable Hand-held

New Product!

## Portable Hand-helds

Manufactured in Ireland by ASH Technologies, Inc.

### Quicklook Classic

2



#### Quicklook Classic ASH-511-301

Convenient and compact, the Quicklook Classic is a cost-efficient, portable and lightweight video magnifier. Take it with you to read price tags, menus, train schedules, etc., and write checks or brief notes by flipping the camera into its writing position.

**Magnification:** 2x - 6x

**Viewing Modes:** Full color, enhanced b/w & w/b, with semi-colors

**Illumination:** LED

**Display:** 4.3" color TFT LCD

**Dimensions (l x w x h):** 6.7" x 3.7" x 1.1"

**Weight:** 11 oz.

**Power:** Built-in rechargeable Li-ion battery. 4-7 hour run time, 3 hour recharge time.

**Other:** Includes freeze frame feature. Camera rotates outward to allow for writing. Easy to grip with its ergonomic, rubberized casing.

### Quicklook Zoom

2



#### Quicklook Zoom ASH-511-201

The Quicklook Zoom is similar to the Quicklook Classic, but with a few additional features such as a larger magnification range and more viewing modes.

**Magnification:** 3x - 18x in 9 steps

**Viewing Modes:** Full color and high contrast w/ 56 color options and on-screen menu.

**Illumination:** LED

**Display:** 4.3" 16:9 high brightness LCD

**Dimensions (l x w x h):** 6.7" x 3.7" x 1.1"

**Weight:** 8.4 oz.

**Power:** Built-in rechargeable Li-ion battery. 4-7 hour run time, 3 hour recharge time.

**Other:** Includes freeze frame feature and on screen menu. Camera rotates outward to allow for writing. Easy to grip with its ergonomic, rubberized casing.

### Quicklook Focus

2



#### Quicklook Focus ASH-511-401

The Quicklook Focus is the premium product in the Quicklook line. In addition to all of the features of the Quicklook Zoom, the Quicklook Focus offers auto-focus and the ability to view objects up to 3 feet away.

**Magnification:** 3x - 18x in 9 steps

**Viewing Modes:** Full color and high contrast w/ 56 color options and on-screen menu.

**Illumination:** LED

**Display:** 4.3" 16:9 high brightness LCD

**Dimensions (l x w x h):** 6.7" x 3.7" x 1.1"

**Weight:** 8.4 oz.

**Power:** Built-in rechargeable Li-ion battery. 4-7 hour run time, 3 hour recharge time.

**Other:** Includes freeze frame feature and on screen menu. Camera rotates outward to allow for writing. Auto-focus feature allows for the viewing of objects a short distance away. Easy to grip with its ergonomic, rubberized casing.

### TVi Color

3



#### TVi Color ASH-508-103

The TVi Color is a hand-held, electronic magnifier that is plugged into your TV to magnify reading material. The camera is housed in the mouse-like device and can be used anywhere there is electricity. It features a handwriting stand for writing notes or signing checks.

**Magnification:** 9x - 18x (on a 14" TV), 13x - 26x (on a 21" TV)

**Viewing Modes:** full color, enhanced b/w, w/b

**Illumination:** LED

**Dimensions (l x w x h):** Camera is 5" x 2" x 2.2" in., base unit is 4" x 3" x 1.4" in.

**Weight:** Camera alone, 3.8 oz (total with base unit is 1 lb. 1 oz.)

**Power:** Electric

**Other:** The camera can be put in 'overview mode' for easy page orientation or can be turned around for use as a 'magnified mirror' for shaving or putting on make-up.

### Portable Desktops

#### 1654-104 Color ELG Video Magnifier

With only 3 buttons, Eschenbach's Color ELG doesn't require reading a training manual before using it. The ELG connects to a TV and provides between 5x - 58.5x magnification, depending on the size of the TV screen. It provides 3 different viewing options: color, black and white, and reverse polarity (white on black). The X-Y table is padded to prevent reading materials from sliding, and the open system allows the user to view all sizes of magazines, books, prescription bottles, etc.

**Magnification:** 5x - 58.5x depending on TV size (TV not included)

**Viewing Modes:** Color, black on white and white on black

**Illumination:** Clip on fluorescent bulb included

**Dimensions (l x w x h):** 17" x 17" x 16.5"

**Weight:** 17 lbs.

**Power:** Electric

**Other:** Sliding X-Y Table Size: 17" x 13"



1654-104

3

#### myReader by Humanware

The myReader is the only video magnifier that can be set by the user to scroll through text manually or automatically at varying speeds that suit the reader. Text can be arranged in column layout, row, word, or original layout. With its built-in 15" display, users can capture up to 13 pages at one time for reading continuity. There are 8 different viewing modes and the myReader folds up into a compact case for easy transportability.

**Magnification:** 0.7x - 45x

**Viewing Modes:** Color, black on white, white on black and 56 possible color combinations.

**Illumination:** 2 fluorescent and 1 halogen bulbs

**Display:** 15" TFT LCD display

**Dimensions (l x w x h):** 19" x 14.5" x 20"

**Weight:** 22 lbs.

**Power:** Electric

**Other:** Includes footswitch, remote control panel,



myReader

3

#### Fusion ASH-515-001

The Fusion is a portable video magnifier with a built-in monitor that rolls over text and images and magnifies them. With its tiltable display and easily removeable mouse-style camera, it is an excellent solution for users that need magnification for near.

**Magnification:** 6x - 16x with high brightness display

**Viewing Modes:** Full color, enhanced positive and negative reading modes

**Illumination:** LED

**Display:** 7 in. TFT LCD display

**Dimensions (l x w x h):** 7" x 7" x 2"

**Weight:** 2 lb. 4 oz.

**Power:** Built-in rechargeable Li-ion battery. 3 hour run time, 4 hour recharge time.

**Other:** Fusion can be used while it is recharging. Legs on camera allow it to be sit on an angle for writing. Carrying case included.



Fusion

3

Manufactured in Ireland by ASH Technologies, Inc.

## ■ Portable Desktops

Manufactured in Ireland by ASH Technologies, Inc.

### Prisma

3



#### Prisma ASH-505-002

The Prisma is a simply designed video magnifier that connects to a TV to view text or images. The Prisma folds into a compact, highly transportable configuration weighing just 2 lbs. 10 oz. Perfect for hobbies, such as needlework, making models, drawing and painting. The Prisma features brightness controls, LED illumination, a writing mat to prevent slippage, and carrying case.

**Magnification:** 3.8x - 35x (on a 14" TV screen)

**Viewing Modes:** Full color display mode with black on white and white on black modes.

**Illumination:** LED

**Dimensions (l x w):** 16" x 9"

**Weight:** 2 lbs. 10 oz.

**Power:** Electric

**Other:** Includes a carrying case and a writing mat that facilitates ease of writing with notes, crossword puzzles, bills, and letters.

### Liberty Solo

3



#### Liberty Solo ASH-509-401

The Liberty Solo is an ergonomically designed, battery powered, portable video magnifier with a 12" screen. Choose a comfortable reading position and enjoy its tiltable display and lightweight mouse camera. Writing is also possible with the flip-out stand on the mouse camera.

**Magnification:** 1x - 30x

**Viewing Modes:** Full color, enhanced positive and negative reading modes, black on white and white on black and a range of semi colors, which are controlled by ergonomic buttons on the mouse unit.

**Illumination:** LED

**Display:** 12" TFT LCD

**Dimensions (l x w x h):** 12" x 10" x 2.4"

**Weight:** 4 lb. 10 oz. (mouse camera: 3.5 oz.)

**Power:** Built-in rechargeable Li-ion battery. 2 hour run time, 3 - 4 hour recharge time.

**Other:** Includes line markers that facilitate reading. Mouse camera features a handwriting stand that flips out to facilitate ease of writing. Carrying case and charger included.

### Opti Lite

5



#### Opti Lite ASH-516-103

Combine the freedom of your laptop with the Opti Lite to create a versatile, mini desktop magnification solution. Ideal for reading and writing, the Opti Lite has a wide range of magnification, fine focus control, and a 10-hour battery life. It's lightweight (2lbs., 10 oz.), so it can be easily carried from one location to another.

**Magnification:** 4x - 40x

**Viewing Modes:** Full color, complete range of enhanced color options with 10 customizable views.

**Illumination:** LED

**Dimensions (l x w):** 16" x 9"

**Weight:** 2 lbs. 10 oz.

**Power:** Built in rechargeable Li-ion battery.

**Other:** Third generation of Opti software is included and provides unique toolbar interface, fully adjustable image window size, image capture and save facility, and full control of video display attributes. Protective carrying case included.



## ■ Transportable Desktops

Manufactured in Ireland by ASH Technologies, Inc.

### Presto ASH-517-001

The Presto is our transportable desktop video magnifier. Its plug-and-play design makes it easy to use; by simply connecting the power cord, it's ready to go. No assembly or set up is required!

**Magnification:** 2.5x - 40x

**Viewing Modes:** Color, black on white and white on black.

**Illumination:** LED

**Display:** 15" TFT LCD

**Dimensions (l x w x h):** 15" x 18" x 7" (when monitor is pulled up, height expands to 21" high)

**Weight:** 20 lbs. 15 oz.

**Power:** Electric

**Other:** Large XY table with breaking system accommodates full page viewing. Features include auto-focus camera and buttons to zoom-in and zoom-out, change image mode and change image enhancement. Optional storage case available with wheels and telescoping handle.



Presto

2

### Eclipse ASH-512-002

The Eclipse is similar to the Presto, but it includes additional features such as enhanced viewing modes and other viewing options such as line markers and blinds. The Eclipse is a powerful performer in the home, work, or educational environment.

**Magnification:** 1.5x - 32x

**Viewing Modes:** Color, black on white and white on black and a wide range of semi colors.

**Illumination:** LED

**Display:** 15" TFT screen, ergonomically positioned for comfort.

**Dimensions (l x w x h):** 15" x 18" x 7" (when monitor is pulled up, height expands to 21" high)

**Weight:** 20 lbs. 15 oz.

**Power:** Electric

**Other:** Large XY table with breaking system accommodates full page viewing. Features include auto-focus camera and buttons to zoom-in and zoom-out, change image mode and change image enhancement. Optional storage case available with wheels and telescoping handle.



Eclipse

3

## ■ Desktops

Manufactured in Ireland by ASH Technologies, Inc.



### Horizon ASH-518-002

The Horizon is a new video magnifier with a host of built-in features, such as a large 19" wide screen (with anti-glare coating), tiltable monitor (so users can read comfortably for extended periods of time), auto and manual focus, and adjustable line markers and shutters that show users exactly where they are on the page at all times.

**Magnification:** 3.5x - 50x

**Viewing Modes:** Full color and a wide range of semi-colors

**Illumination:** LED

**Display:** 19" TFT LCD

**Dimensions (l x w x h):** 16.5" x 18" x 21"

**Weight:** 23.5 lbs.

**Power:** Electric

**Other:** Large XY table with breaking system accommodates full page viewing. Features both automatic and manual focus.



Horizon

3

### iFlex ASH-506-501

The iFlex is a unique solution for magnification at home or work where maximizing desk space is key. Easy to attach and detach from a standard computer monitor arm (not included), it allows for easy transportation.

**Magnification:** 3x - 50x

**Viewing Modes:** Color, black on white and white on black and a wide range of semi colors.

**Illumination:** LED

**Display:** 15" TFT LCD

**Dimensions (l x w x h):** 17.5" x 16.5" x 4.5"

**Weight:** 9 lbs.

**Power:** Electric

**Other:** Customized carrying case, footswitch, and video lead included.



i Flex

3

# Video Magnifiers

## Desktops w/ Distance Camera

### Liberty Scholar

4



## Portable Desktops w/ Distance Camera

Manufactured in Ireland by ASH Technologies, Inc.

### Liberty Scholar ASH-509-202

An ideal magnification solution that includes a mouse camera, 12" integrated display, and a top-mounted pan-and-tilt zoom camera. Rechargeable batteries allow the system to be used when there is no access to power outlets.

**Magnification:** 12x - 27x

**Viewing Modes:** Full color and enhanced display modes

**Illumination:** LED

**Display:** 12" TFT LCD

**Dimensions (l x w x h):** 11.8" x 9.8" x 2.4"

**Weight:** 5 lb. 2 oz.

**Power:** Built-in rechargeable Li-ion battery. 1-3 hour run time, 3 - 4 hour recharge time.

**Other:** Distance camera offers 10x optical zoom.

### Opti Verso ASH-516-203

The ultimate portable reader for professionals and students who require distance AND close-up viewing, as well as writing capability. The Opti Verso has a collapsible design for easy portability.

**Magnification:** 2x - 20x (80x digital) on a typical 15" screen

**Viewing Modes:** Full color, range of color options, 10 customizable views

**Dimensions (l x w x h):** 16" x 9.4" x 13" (collapsing to 2.5")

**Weight:** 2 lbs. 11 oz.

**Power:** Built-in rechargeable Li-ion battery. 6 hour run time, 3 - 4 hour recharge time.

**Other:** USB lead, Opti software, power cord, power supply/charger, and carrying case included. 10x zoom control is possible from the camera or keyboard.

### Opti Verso

5



## Transportable Desktops w/ Distance Camera



### i-Qon ASH-519-101

The i-Qon is a 2-piece system that allows the TVi Color or Prisma to be used with a computer monitor. Split screen technology lets users view both their computer screen and the image projected by the TVi Color or Prisma on their computer monitor. The i-Qon offers adjustable line markers which facilitate easier text tracking and reading.

**Camera Image Modes:** Full color with complete range of enhanced color options.

**Weight:** Main unit - 17 oz.; keypad - 11 oz.

**Dimensions (l x w x h):** Main unit - 8.8" x 4" x 1"; Key pad - 4" diameter, 1" in height.

**Other:** Main unit, keypad, power supply and cable, video lead, and footswitch included. (A camera is required for use with this system.)

### Agilo ASH-520-002

The Agilo is a 3-piece system (the 2-piece i-Qon and a camera mounted on an adjustable arm) that works with a computer and existing monitor. Split screen technology lets users simultaneously view both their computer screen and the image projected by the camera on their computer monitor.

**Camera Image Modes:** Full color and high-contrast reading modes with a complete range of color options. Features line and line marker modes, and freeze image function.

**Weight:** Main unit - 17 oz.; keypad - 11 oz.

**Other:** Main control unit, keypad, camera w/ adjustable arm, power supply and cable, video lead, and foot switch included.

### Eclipse Scholar ASH-512-202

The Eclipse Scholar is the premier one-piece integrated design that can be used for reading, writing, and viewing distance objects. For use in the home, at work, or in an educational environment, it contains a top-mounted camera, full color, continuous autofocus, line markers and overview mode.

**Magnification:** 1.5x - 30x, 10x zoom on distance camera

**Viewing Modes:** Color, black on white and white on black and a wide range of semi colors.

**Illumination:** LED

**Display:** 15" TFT screen, ergonomically positioned for comfort

**Dimensions (l x w x h):** 15" x 18" x 7" (when monitor is pulled up and camera is attached, height expands to 25" high)

**Weight:** 21 lbs. 7 oz.

**Power:** Electric

**Other:** Large XY table with breaking system accommodates full page viewing. Features auto-focus camera with mirror and freeze modes. Camera, mounting bracket, Eclipse, carrying case w/wheels, and all power supplies included.

### i-Qon

5



### Agilo

5



### Eclipse Scholar

4



## Multi-purpose magnifiers

### Slide-out and folding magnifiers

#### 1103 / 1104

**Technical data:**

- Slide-out magnifier has a durable plastic case
- Compact and versatile-fits into pocket or purse
- With two plano-convex PXM® lightweight lenses
- 1103 has two lenses, each with two magnifications
- 1104 has two lenses, each with one magnification

Product #	Magnification
1103	3x and 4.5x or 6x and 9x
1104	3x or 6x



1103  
1104

3

#### 1109-10

**Technical data:**

- Folding magnifier has protective, durable case
- Lightweight, tapered, fits easily into any pocket
- Aplanatic distortion free PXM® lightweight lenses
- Duplex anti-static, anti-scratch coating

Product #	Lens size	Magnification
1109-10	23 mm	10x



1109-10

3

#### 1116-30 Students' and pupils' magnifier

**Technical data:**

- Bi-convex PXM® lightweight lens
- Handle and frame are transparent
- Packaged in packs of 10

Product #	Lens size	Magnification
1116-30	30 mm	5x



1116-30

3

#### 1163 Handle magnifier in lightweight metal frame

**Technical data:**

- Aspherical PXM® lightweight lens
- Duplex coating
- Black plastic handle, black, anodized, plastic frame

Product #	Lens size	Magnification
1163	50 mm	6x



1163

3

# Technical Magnifiers

■ Hand-held



## Precision folding magnifiers

### 1186-9 / 1182-10

#### Plastic Precision Folding Magnifiers

##### Characteristics:

- The body is made of reinforced glass-fiber, durable polyamide
- The air tight body prevents dust, which produces scratches, from entering

##### Technical data:

- Glass lenses
- Size: 23 mm

Product #	Lens	Magnification	Characteristics
1186-9	Achromatic	3x + 6x = 9x coated	color aberration-free image
1182-10	Aplanatic	10x	distortion-free image

### Metal Precision Folding Magnifiers

Traditional, technical folding magnifiers provide the high power optics and durability to meet any industry standard.

#### Achromatic Lens

The unique achromatic lens system eliminates color aberration. It consists of coated lenses that are cemented together using different types of glass. The result is crystal-clear optics with no color aberration.

#### Aplanatic Lens

Provides a distortion-free image. The two plano-convex glass lenses offer distortion-free, superior optics throughout the viewing field.

#### Technical Information:

**Mount:** Black metal lens frame

**Handle:** Chrome-plated brass

Product #	Lens Size (mm)	Magnification	Lens
1176-6	23	6x	Aplanatic
1176-8	23	8x	Aplanatic
1176-10	23	10x	Aplanatic
1176-12	23	12x	Aplanatic
1178-10	17	10x	Aplanatic
1178-15	17	15x	Aplanatic
1178-20	17	20x	Aplanatic
1177-5	30	5x	Biconvex
1184-10	17	10x	Achromatic
1184-20	17	20x	Achromatic
1187	30	4x + 6x = 10x	Biconvex

# Technical Magnifiers

■ Hand-held & Stand

## 1171 Tube Microscope

### Characteristics:

- The broad focusing range makes it possible to inspect raised or submerged elements (e.g., holes)
- The wide adjustable range compensates even serious defective vision of the users
- High degree of brilliance is achieved by the large objective aperture. In daylight no additional lighting is necessary

### Technical data:

- Glass achromatic lenses with Huygens eyepieces
- Magnification: 40x
- All lens surfaces are coated giving high illuminance
- Focus adjustable optics precision glass measuring scale, graduation 0.05 mm



1171-1

2

## 1174 Micro-magnifier with illumination

### Characteristics:

- Precise focusing with adjustable wheel
- Illumination can be connected, if required

### Technical data:

- Glass lenses
- Magnification 30x
- Batteries (2 AA) included
- Bulb 2.2 V, 250 mA, E10
- Replacement bulb no.1543 (see page 18)



1174

2

## Aspheric Stand Magnifiers

Eschenbach high power stand magnifiers are ideal for any visual task that requires high magnification.

### Special Features:

- The transparent, plastic base lets in maximum light for clear, bright viewing
- All have an open base for marking underneath
- Magnification/dioptric value/ideal eye-lens distance printed on all lens heads

### Technical Information:

**Lens:** Aspheric PXM® lightweight lens with cera-tec® scratch resistance coating

**Mount:** White plastic frame

**Base:** Transparent plastic base provides easy access to material being viewed

**Note:** Open base for writing

Product #	Lens Size (mm)	Dpt.	Magnification
2626	50	23	6x
2628	35	38	10x



2626

3



2628

3

 **cera-tec®**  
coating

## 1153

### Aplanatic Stand Magnifier

Ideal for looking at film negatives and photographs

### Technical Information:

**Magnification:** 8x (32D)

**Lens:** Aplanatic PXM® lightweight lens with cera-tec® coating

**Lens Size:** 25 mm



1153

3

## 1124 and 1130

### Watchmakers' magnifier, stone magnifier

### Characteristics:

- Includes vent to prevent condensation
- Made of flame resistant plastic material

### Technical data:

- PXM® lightweight lens with duplex anti-static, scratch resistant coating
- Color: anthracite

Product #	Magnification	Lens	Lens Diameter
1124-3	3x	plano-convex	25 mm
1124-5	5x	plano-convex	25 mm
1124-7	7x	plano-convex	25 mm
1124-10	10x	bi-convex	25 mm
1130	15x	2-lens system	13 mm



1124-3

1124-5

1124-7

1124-10

3



1130

3

# Technical Magnifiers

■ Stand

1154-7  
1154-10

3



1152-01  
1152-02  
1152-03  
1152-04

3

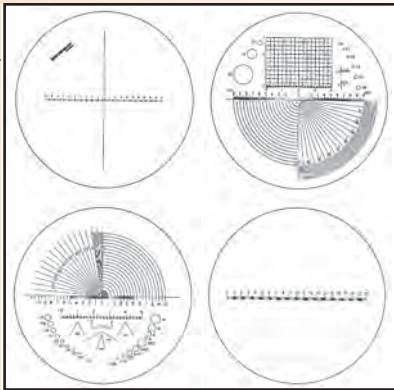

1151

3



## 1154

### Characteristics:

- Clear, distortion-free image
- Fine focusing via handy focusing ring
- Exchangeable precision measuring scales for various applications

### Technical data:

- Achromatic glass lens, coated
- Housing made of glass-fiber-reinforced polyamide
- Supplied with standard scale no. 1152-01, measuring range 20 mm, 1/10 mm graduation  
Comes in a solid plastic box providing space for other scales
- Lens Diameter: 23 mm

Product #	Diopter	Magnification
1154-7	28	7x
1154-10	40	10x

### Accessories:

**Precision measuring scales** for various applications  
Order no. 1152-01, 1152-02, 1152-03, 1152-04

## 1151

### Characteristics:

- Illumination unit for precision scale magnifiers 1154-7 and 1154-10

### Technical data:

- Handle uses 2 C batteries (not included)
- Supplied with bulb 1545

### Accessories:

Electric handle w/ halogen light  
Order no.: 1599-304 (see page 18)

## ■ Linen Testers

### Linen Testers

**Technical Information:**

**Lens:** Biconvex, optically ground silicate glass

**Body:** Brass, chrome-plated, matte finish

**Case:** Leather cases available, see below

Product #	Magnification	Height (mm)	Lens Size (mm)	Cut Out (mm)	Case Number
<b>1254</b>	12x	23	12.6	10x10	1200-1
<b>1255</b>	10x	27	14.6	15x15	1200-2
<b>1256</b>	8x	33	17.6	20x20	1200-3
<b>1258</b>	6x	42	22.6	25x25	1200-4
<b>1259</b>	5x	53	23.6	30x30	1200-5

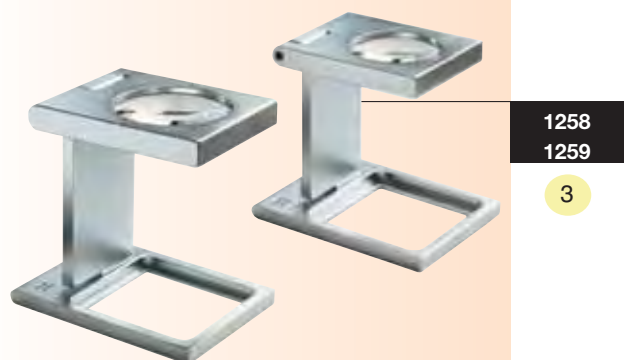
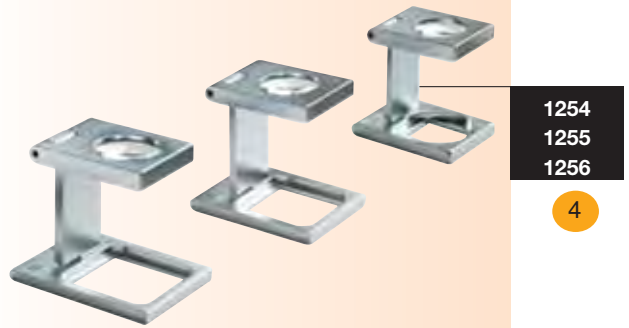

### Aplanatic Linen Testers with Scale

**Magnification:** 8x

**Lens:** Aplanatic

**Cut-out:** 18 mm Ø

**Height:** 33 mm

**Diameter:** 15 mm

Product #	Scale	Case Number
<b>1266-91</b>	Square scale 1/10 mm	1200-3
<b>1266-92</b>	Line scale 1/10 mm	1200-3

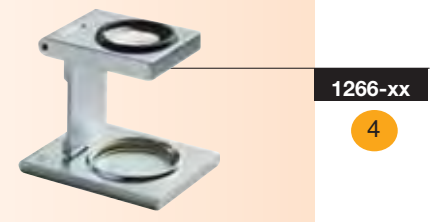

### Plastic Linen Testers with Lateral mm Scale

Product #	Magnification	Height (mm)	Lens Size (mm)	Cut Out (mm)	Case Number
<b>1270</b>	5x	56	23.6	30x30	1200-5
<b>1271</b>	10x	28	14.6	15x15	1200-2
<b>1272</b>	8x	35	17.6	20x20	1200-3



# Non-Optical Products

## ■ Task Lighting

1602-04

1



Eschenbach Task Lighting options provide the best illumination for any user. Versatile, and of the highest quality, these valuable lightsources are only available from Eschenbach!

### 1602-04 Halogen Desk Lamp

#### Special Features:

- Well ventilated - "stays cool"
- Broad beam lamp with halogen light
- Provides strong illumination for any visual task
- Telescopic arm and swivel head allows a variety of positions for any task

**Material:** White plastic

**Arm Support:** Up to 41 cm (approximately 16 inches)

**Bulb:** 1602-2 (included)

**Transformer:** 110 v/U.S. plug

1603-04

1

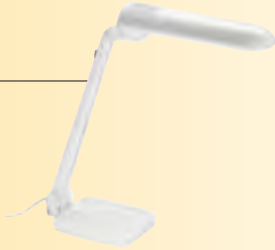

### 1603-04 Fluorescent Desk Lamp

#### Special Features:

- "Always cool" fluorescent light
- Tilting head and flexible arm for maximum adjustability
- Compact and portable

**Material:** White plastic

**Arm Support:** Flexes to varying angles

**Bulb:** 1603-827 (yellow) included

1603-850 (white) available as an option

**Transformer:** 120 v/U.S. plug

1604-104

1



### 1604-104 LED Bar Light

#### Special Features:

The LED Bar Light features 6 LEDs which create bright, uniform, non-glare illumination precisely where it's needed. About the size of a pencil, it easily attaches to a number of magnifiers and is light enough to attach to magnifying eyewear. The LED Bar Light connects to a broad range of magnifiers, such as: 2031-2036, 1648-xx, 2678, 2774, 1681-xx (needs additional 1604-11 clip), 1682-xx (needs additional 1604-11 clip).

#### Technical Information:

**Illumination:** 6 LEDs

**Transformer:** Electric (no batteries to change!)

**Attachments:** Includes 4 different clips that allow it to attach to a broad range of magnifiers

1604-11

1



### 1604-11 LED Bar Light Clip

#### Special Features:

The LED Bar Light Clip allows the LED Bar Light to attach to Eschenbach magnifying eyewear such as the noves mono (1681-xx) and noves bino (1682-xx). The Clip opens 15 mm and includes rubber protectors at the ends of the clip to prevent lens scratching.

### 2090-04 Super-Lite

#### Special Features:

- Specially designed to provide illumination for a large rectangular field
- The fluorescent bulb provides superior illumination and lasts up to 2,000 hours!
- The Super-Lite kit contains 4 clips allowing the light to be attached to a variety of products (such as the 2678, 2774, 2777, 2032, 2655-175, 2655-150, and 2655-750).

#### Technical Information:

**Illumination:** Fluorescent

**Bulb:** 2090-41 included, 5 watts, 4000 Kelvin (white)

2090-21 available as an option, 5 watts, 2700 Kelvin (yellow)

**Transformer:** 120v/US plug, 60Hz

2090

1



### 6949-2 LED Headlight

#### Special Features:

Eschenbach's battery operated LED Headlight is perfect for those who need extra illumination from a hands-free, battery operated product. The LED Headlight is powered by 3 AAA batteries and the battery life is over 30 hours. The adjustable elastic strap is comfortable to wear and stays securely in place. In addition, the on-off switch allows you to turn on one, two or three LEDs independently according to how much illumination is needed.

#### Technical Information:

**Illumination:** 3 LEDs

**Power Source:** 3 AAA batteries (included)

**Housing:** LEDs are housed in a ratcheting mechanism that allows the user to adjust the upward/downward angle of the light.

**Weight:** only 5.5 ounces

6949-2

1



### 1600 Table Clamp

This table clamp can turn any hand-held magnifier into a "hands-free" magnifier, or can be used to position smaller objects for easier viewing.

#### Special Features:

- Flexible metal, gooseneck arm with 2 clamps made from high quality black plastic with sponge rubber disks for firm contact on smooth surfaces
- Gooseneck arm is 330 mm (13") in length
- Clamping jaws open to approximately 40 mm (1.6")



1600

1

### 1605 Reading Stand

Helps users position their reading material at a height and angle that makes the reading task easier.

#### Characteristics:

- By using the reading stand and vision aid concurrently, optimum view is always achieved due to the identical distance to the reading material, which the vision aids provide.
- The reading stand supports an upright, orthopedically correct position, preventing backaches.

#### Technical data:

- Supporting area: 40 x 35 cm
- Natural maple wood
- 5 different inclines possible
- Edge stopper prevents slipping
- Supplied with clamp attachment for large papers

**Note:** The reading stand should be re-aligned each time magnifying vision aids are adjusted.

#### Accessories

##### 1605-1 Guide Rail (not shown)

#### Use:

- Elderly people frequently have problems with guiding magnifiers and magnifying readers. The guide rail facilitates orientation on a line of text.
- The guide rail can be secured at any height using a fixing screw.

#### Technical data:

- Natural maple wood



1605

1

### C-500 Reading Stand

- Designed to provide a comfortable reading position when using a high power magnifier
- Magnetic strips on the back side of clip board allow the height to be adjusted
- Comes complete with 1 vertical clipboard

#### Technical Data:

- Solid Poplar Wood



C-500

1

# Non-Optical Products

## Accessories

C-Sim Kit 4



### C-Sim Kit 4

#### Low Vision Simulator Kit

This kit demonstrates the four major eye diseases that cause low vision: macular degeneration, diabetic retinopathy, cataracts, and glaucoma.

C-100



### C-100

#### Eschenbach Reading Card for Near

- Provides an effective method to expedite the process of determining the needed magnification within minutes!
- Also available in Spanish (C-100-S) and French (C-100-F).

#### Usage Note:

- Each line of text lists the Snellen near equivalent (at 16"), M notation, dioptric power requirement and magnification requirement.
- To use, simply have the patient read the chart, holding it at a comfortable reading distance with best corrected vision. When the patient can no longer read the print, make a note of which line could not be read. Above that line to the right is the approximate magnification and dioptric powers needed to read standard news print.

C-300

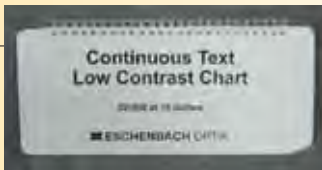

### C-300

#### Continuous Text Low Contrast Card

- Printed at 20/400 acuity, it can be read by most patients, and includes 5 pages printed with either 25%, 10%, 5%, 2.5% or 1.25% contrast sensitivity function scores
- Printed on sturdy polystyrene with high-quality matte finish
- Wired-bound pages are off-set for easy flipping
- Continuous text design for better measurement of reading speed

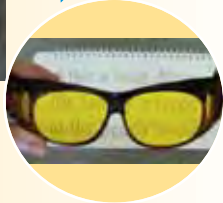

DVI-Chart



### DVI-Chart - Distance Reading Chart

The Original Distance Test Chart for the Partially Sighted is our recommended distance acuity testing tool. The "Feinbloom Number Chart" has been the standard of care among low vision professionals for decades! The acuity test, calibrated for use at 10 feet, allows the flexibility to adjust the distance acuity measuring process to meet the abilities of the patient.

#### Features include:

- 10' optotypes, from 10/10 to 10/700, allow for the most precise distance acuity measurement possible
- Constructed from heavy gauge laminated paper-durable vinyl covers
- Spiral binding allows for quick optotype changes
- Testing distance can be adjusted at the discretion of the practitioner



Patient Travel Kit



### 1848 Patient Travel Kit

Help protect your patient's low vision devices. Sturdy and lightweight, the Patient Travel Kit features 6 flexible sized compartments that accommodate over 100 different sizes and shaped Eschenbach products. Velcro pouch on inside cover provides additional storage space. Soft carrying handles with an adjustable shoulder strap and a business card slot on the outside makes the perfect travel companion!



D-Mkit



### D-Mkit - Marketing Resource Kit

Eschenbach's Marketing Resource Kit is designed to assist in growing low vision services in your practice! Materials include:

- Poster (designed to inform the visually impaired that you may be able to help them!)
- Consumer Brochures
- Folder with pre-evaluation forms, a customizable consumer flyer, and copies of "boiler-plate" referral letters
- CD with electronic copies of printed documents in the folder
- Post-it Notes printed with "Low Vision Candidate?", designed to help identify patients who might need a low vision evaluation

Consumer Brochure



### Consumer Brochure - CAT-Consumer

The Consumer Brochure is designed to educate consumers about low vision devices and how they can benefit those with low vision on a daily basis. Common eye diseases, such as macular degeneration and diabetic retinopathy are explained and tips on living with low vision are discussed.

### 1860 Optoform® Display

- Attractive and sturdy display holds over 100 vision aids in less than four square feet
- Mobile! The display is on casters so it can be moved around in your office
- Holds up to 11 single trays
- Closed storage cabinet and slide-out shelf on bottom
- Customizable sign on top allows you to personalize the display
- Dimensions: Height 72 inches, Width 22 inches, Depth 18 inches
- Display trays keep products dust-free and are labeled for easy reordering of dispensed items

**Note:** Products and trays not included. Assembly required.



1860

### 1855 Dispensing Cabinet with Shelf

- Sturdy white cabinet locks to store your vision aids securely.
- Mobile! The cabinet is on casters so it can be moved around in your office
- Holds up to 9 single trays
- Fold-out shelf provides larger working area, and can be mounted on either side
- Dimensions: Height 30 inches, Width 17 3/4 inches, Depth 24 inches
- Cabinet is shipped fully assembled
- Trays are labeled for easy reordering of dispensed items

**Note:** Products and trays not included



1855

### 1860-5 Mini-Optoform® Display

Specially designed for countertop use, this smaller version of the Optoform® dispensing system can hold up to five single trays of ESCHENBACH products. Perfect for retail or a satellite office.

Customizable sign on top allows you to personalize the display for marketing purposes.

#### Dimensions

**Height:** 34 3/4" (with sign), 19 3/4" (without sign)

**Width:** 23"

**Depth:** 15 1/2"

**Note:** Detachable sign allows unit to fit between counter top and overhead cabinetry in most exam rooms. Products and trays not included.



1860-5

### 1852 Portable Low Vision Kit

Developed with the needs of the itinerant low vision provider or satellite office in mind, this lightweight case holds 32 vision aids securely in a protective foam tray. With powers ranging from 2.8x to 10x and a variety of head borne, hand-held and stand devices, this kit will allow you to treat visually impaired patients anywhere!

**Contents:** 1510-10, 1510-34, 1510-5, 1510-74, 1544, 1550-73, 1551-73, 1552-73, 1553-93, 1554-93, 1582-93, 1591-704, 1599-10, 1599-40, 1599-304, 1624-1, 1710-14, 1740-560, 2614-65, 2626, 2655-175, 2655-60, 2668-60, 2855-175, 2855-60, 2858-65, 4293-616, 4294-413, B3000-6, B3000-8, B3000-10, C-100, C-300, 1852-1, and DVI-Chart.

Also available: 1852-1 – carrying case without product



1852

2815-04

1



Page 8 & 11

2822-04

1 - 3



Page 13

2845

1 - 2



Page 7

15107

1 - 4



Page 5

## ■ Diagnostic Dispensing System Display Trays

These seven trays make up our most comprehensive assortment of products. See the pages indicated for more information on each one.

### 2815-04 Aplanatic and Biconvex Assortment (Tray #1)

A diagnostic tray of biconvex and aplanatic hand-held magnifiers.

Contents: 9 pieces

2614-150, 2614-65, 2614-80, 2614-840, 2668-50, 2668-60, 2668-75, 2668-85, 2668-950. Tray-insert 2815-1304 included at no charge with purchase of assortment.

Optionally available:

1880 white display tray with 1882-2 acrylic cover.

### 2822-04 Diagnostic Tray of Pocket and Bright Field Magnifiers (Tray #2)

Contents: 11 pieces

1420, 1436, 1710-14, 1710-67, 1710-910, 1740-160, 1740-530, 1752-850, 2050-1, 2605, 2678. Tray-insert 2822-304 included at no charge with purchase of assortment.

Optionally available:

1880 white display tray with 1882-2 acrylic cover.

### 2845 Diagnostic Tray of Aspheric Magnifiers (Tray #3)

Contents: 6 pieces:

2655-50, 2655-60, 2655-70, 2655-750, 2655-150, 2655-175. Order cases individually or as case assortment 2845-C. Tray-insert 2845-3 included at no charge with purchase of assortment.

Optionally available:

1880 white display tray with 1882-2 acrylic cover.

### 15107 Diagnostic Tray of Illuminated Hand-held Magnifiers (Tray #4)

Eschenbach's broad assortment of illuminated hand-held magnifiers in one convenient display tray. The assortment features a range of magnification from 3x to 12.5x, as well as both LED and incandescent light sources.

Contents: 11 pieces:

1510-2, 1510-3, 1510-41, 1510-5, 1510-24, 1510-34, 1510-74, 1510-104, 1510-124. Tray-insert 15107-304 included at no charge with purchase of assortment.

Optionally available:

1880 white display tray with 1882-2 acrylic cover.

### 18283 Diagnostic Tray of Illuminated Stand Magnifiers (Tray #5)

This tray contains a complete assortment of our best selling illuminated stand magnifiers.

Contents: 12 pieces:

1550-73, 1551-73, 1552-73, 1553-93, 1554-93, 1557-73, 1559-93, 1580-63, 1559-304, 1559-40, 1591-704. Tray-insert 18283-304 included at no charge with purchase of assortment.

Optionally available:

1880 white display tray with 1883-2 acrylic cover.

See technical data regarding Eschenbach Stand Magnifiers on page 61.



Page 17

18283

1 - 4

### 1697 Diagnostic Tray of noves eyewear (Tray #6)

Contents: 13 pieces:

1681-3-L, 1681-3-R, 1681-4-L, 1681-4-R, 1681-5-L, 1681-5-R, 1681-6-L, 1681-6-R, 1682-4, 1682-5, 1682-6, 1682-8, 1682-10.

Tray-insert 1697-73 included at no charge with purchase of assortment.

Optionally available:

1880 white display tray with 1882-2 acrylic cover.



Page 26

1697

1 - 4

### 1696 Diagnostic Tray of Galilean, Keplerian and Clip-on Vision Aids (Tray #7)

Contents: 17 pieces:

1510-25, 1624-1, 1624-5, 1631, 1634, 1634-4, 1644-504, 1646-70, 1645-1, 1645-2, 1645-3, 1645-4, 1645-5, 1671-1, 1673-1, 1673-2, 1673-3. Tray-insert 1696-1304 included at no charge with purchase of assortment.

Optionally available:

1880 white display tray with 1882-2 acrylic cover.



Page 37

1696

1 - 4

## Useful Information about Magnifiers and Eschenbach Lenses

### Lens Designs Used in ESCHENBACH Vision Aids

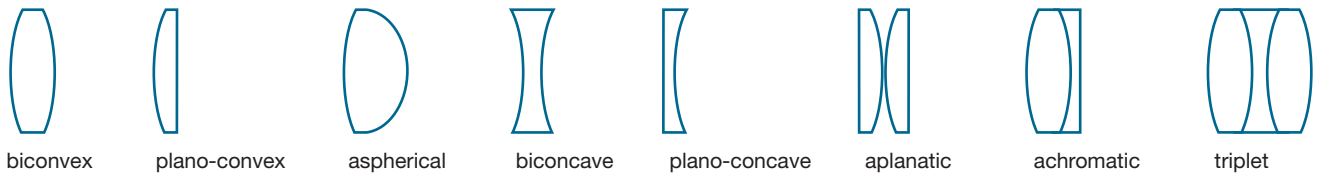

### Table of Near Vision Equivalents

1 Foot = 12 inches = 0.3048 m, 1 inch = 2.54 cm  
 1m = 3.2808 feet, 1 cm = 0.3937 inch.

\* For US-market use dec.: US Snellen conversion

$$\text{Magnification requirement} = \frac{\text{Visual acuity (best corrected)}}{\text{Visual acuity objective}}$$

Dec.	Log Mar	*US Snellen	Metric Print Size	Npoint	Metric Print Size
			for testing at 25 cm		
			for testing at 40cm (16 inch)		
1.0	0.0	20/20	0.4 M	N2	0.25 M
0.8	0.1	20/25	0.5 M	N2.5	0.32 M
0.666	0.2	20/30	0.6 M 6Pt.	N3.2	0.4 M
0.5	0.3	20/40	0.8 M	N4	0.5 M
0.4	0.4	20/50	1.0 M	N5	0.63 M
0.333	0.5	20/60	1.25 M 12Pt.	N6.3	0.8 M
0.25	0.6	20/80	1.6 M	N8	1.0 M
0.2	0.7	20/100	2.0 M 18Pt.	N10	1.25 M
0.16	0.8	20/125	2.5 M	N12.5	1.6 M
0.125	0.9	20/160	3.2 M	N16	2.0 M
0.1	1.0	20/200		N20	2.5 M
0.08	1.1	20/250		N25	3.2 M
0.065	1.2	20/320		N32	4.0 M
0.05	1.3	20/400		N40	5.0 M

### Design and Use of Stand Magnifiers

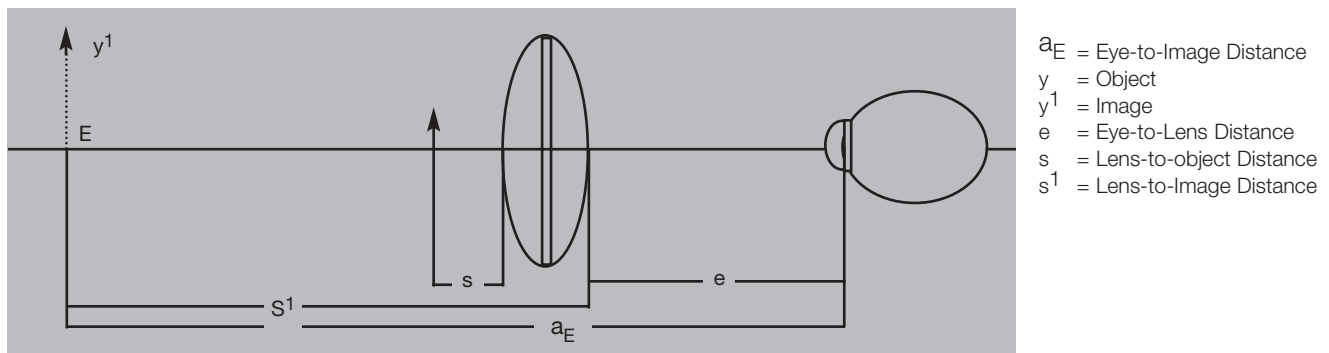

The Equivalent Power of a stand magnifier (the equivalent spectacle lens power) is the Transverse Magnification (TM), also called the Enlargement Ratio, multiplied by 1 meter/Eye-to-Image distance (aE) in meters. Therefore, EP=(TM)\*(1/aE). The Transverse Magnification (TM) of a stand magnifier is the Lens-to-Image distance (s<sup>1</sup>) / Lens-to-Object distance (s). Therefore, TM=s<sup>1</sup>/s. See next page for details on ESCHENBACH Stand Magnifiers.

## Technical Data for Eschenbach Stand Magnifiers

Product Number	Magnification $V=D/4$ or $\dagger V = D/4 + 1$	Diopter $[D]=1/f$	Lens Size (mm)	Lens Type	Eye-to-Lens Distance (mm)	Lens-to-Image Distance (mm)	Eye-to-Image Distance (mm)	Transverse Magnification/ Enlargement Ratio	Maximum Allowable Add (diopter)
<b>1153</b>	8x	28.7	25	aplanatic	40	321	361	9.1	3.0
<b>1420/21</b>	2x*	16*	65	spherical	Not Specified	50	400	1.7*	20
<b>1424</b>	1.8x	7.2	45	spherical	Not Specified	Not Specified	400		
<b>1426</b>	1.8x	7.2	65 x 36 x 46	aspheric	Not Specified	Not Specified	400		
<b>1436/-1</b>	2.2x*	4.8*	90 x 35 x 70	aspheric	Not Specified	125	400	1.7*	8
<b>1436-2</b>	3.6x*	10.4*	90 x 35 x 70	aspheric	Not Specified	125*	400*	1.7*	8*
<b>1557</b>	12.5x	50	35	aspheric	40	360	400	18.3	2.8
<b>1550</b>	10x	38	35	aspheric	40	360	400	12.4	2.8
<b>1551</b>	7x	28	35	aspheric	60	340	400	10	2.9
<b>1552</b>	6x	24	50	aspheric	100	300	400	7.8	3.3
<b>1553</b>	5x	20	60	aspheric	140	260	400	5.9	3.9
<b>1554</b>	4x	16	70	aspheric	150	250	400	4.7	4.0
<b>1559</b>	3x	12	80	aspheric	250	150	400	3.1	6.7
<b>1565-1</b>	2.8x†	7	100 x 75	aspheric	250	150	400	2	6.7
<b>1580</b>	3x†	7.6	100 x 50	aspheric	250	150	400	2.2	6.7
<b>1580**</b>	4x	11.6	100 x 50	aspheric	190	210	400	3.2	4.8
<b>1582</b>	2.8x†	7	100 x 75	aspheric	250	150	400	2	6.7
<b>1582**</b>	3.8x	10.5	100 x 75	aspheric	220	180	400	2.8	5.6
<b>1585</b>	3.9x	11.4	100 x 50	doublet	200	200	400	3.1	3.8
<b>2031</b>	2.8x†	6.3	100 x 50	aspheric	250	150	400	2	6.7
<b>2032</b>	2.8x†	7	100 x 75	aspheric	250	150	400	2	6.7
<b>2034</b>	3.5x†	10	75 x 50	aspheric	250	150	400	2.9	6.7
<b>2036</b>	2.8x†	6.3	100 x 50	aspheric	250	150	400	2	6.7
<b>2636-7</b>	2.8x†	7	100 x 75	aspheric	250	150	400	2	6.7
<b>2636-11</b>	3.8x†	11	100 x 75	aspheric	250	215	465	3	4.9
<b>2626</b>	6x	23	50	aspheric	100	300	400	7.8	3.3
<b>2628</b>	10x	38	35	aspheric	40	360	400	12.4	2.8
<b>2629</b>	12.5x	50	30	aspheric	40	360	400	18.3	2.8
<b>2632-10</b>	2.5x	10	90 x 25	aspheric	250	150	400	2.3	6.7

\* Estimates

\*\* when using flip-up internal lens

Article number	Magnification		Visual fields * approx. values	Angle	Working distance in mm	Objective Lens diameter in mm	Weight in g
1621	2.2x	long	*250 m/1000 m	14.0°	∞	23	16
1621 + 16213	1.65x	short	*67 mm	12.0°	app. 330	27	22
1621 + 16214	2.2x	short	*54 mm	12.0°	250	27	22
1621 + 16215	2.75x	short	*44 mm	12.0°	200	27	22
1621 + 16216	3.3x	short	*35 mm	12.0°	167	27	22
1621 + 16218	4.4x	short	*25 mm	12.0°	120	27	22
1621 + 162110	5.5x	short	*22 mm	12.0°	100	27	22
1621 + 162112	6.6x	short	*18 mm	12.0°	83	27	22
1621 + 162116	8.8x	short	*14 mm	12.0°	63	27	22
1622-5	2.5x	long	230 m/1000 m	13.0°	∞	25	12
1623	2x	long	400 m	22.0°	∞	37	17
1623-3	2.5x	short	113 mm	20.0°	330	42	33
1623-4	3.0x	short	94 mm	20.0°	250	42	33
1623-5	3.5x	short	81 mm	20.0°	200	42	33
1623-6	4.0x	short	71 mm	20.0°	167	42	33
1623-8	5.0x	short	57 mm	20.0°	125	42	33
1623-10	6.0x	short	48 mm	20.0°	100	42	33
1623-12	7.0x	short	41 mm	20.0°	83	42	33
1634	3x	long	*160 m/1000 m	9.5°	700 to ∞	23	70
16344	4x	long	*130 m/1000 m	7.5°	780 to ∞	23	70
16362	2.5x	short	*91 mm/350 mm	15.0°	app. 350	23	70
16363	3x	short	*54 mm/200 mm	12.5°	app. 200	23	70
16364	4x	short	*34 mm/250 mm	8.0°	app. 250	23	70
1638							
1639							
16731	2.8x	long	220 m/1000 m	12.5°	150 to ∞	9	25
	3.4x	short	26 mm/150 mm	10.0°			
16731 + 16213	2.1x	short/long			90-337		
16731 + 16215	2.8x	short/long			83-260		
16731 + 16215	3.5x	short/long			76-207		
16731 + 16216	4.2x	short/long			70-173		
16731 + 16218	5.6x	short/long			60-124		
16731 + 162110	7.0x	short/long			53-100		
16731 + 162112	8.4x	short/long			48-80		
16731 + 162116	11.2x	short/long			40-61		
16732	4.2x	long	175 m/1000 m	10.0°	200 to ∞	10	30
	5.5x	short	25 mm/200 mm	7.2°			
16732 + 16213	3.15x	short/long			133-317		
16732 + 16214	4.2x	short/long			117-241		
16732 + 16215	5.25x	short/long			104-190		
16732 + 16216	6.3x	short/long			95-165		
16732 + 16218	8.4x	short/long			78-119		
16732 + 162110	10.5x	short/long			67-97		
16732 + 162112	12.6x	short/long			58-79		
16732 + 162116	16.8x	short/long			47-60		
16733	4.2x	long	220 m/1000 m	12.5°	200 to ∞	12	55
	5x	short	32 mm/200 mm	9.2°			
16733 + 16213	3.15x	short/long			112-323		
16733 + 16214	4.2x	short/long			101-245		
16733 + 16215	5.25x	short/long			91-191		
16733 + 16216	6.3x	short/long			83-166		
16733 + 16218	8.4x	short/long			71-122		
16733 + 162110	10.5x	short/long			61-97		
16733 + 162112	12.6x	short/long			53-78		
16733 + 162116	16.8x	short/long			44-60		
16734	6x	long	185 m/1000 m	10.5°	250 to ∞	17	60
	7.6x	short	26 mm/250 mm	6.0°			
16734 + 16213	4.5x	short/long			128-333		
16734 + 16214	6.0x	short/long			113-249		
16734 + 16215	7.5x	short/long			101-196		
16734 + 16216	9.0x	short/long			92-166		
16734 + 16218	12.0x	short/long			76-122		
16734 + 162110	15.0x	short/long			66-97		
16734 + 162112	18.0x	short/long			57-79		
16734 + 162116							

\* In Galilean Systems the actual field of view depends on the distance between eye end eyepiece. Therefore the values for the visual field are average values.  
Technical specifications subject to change without prior notice. (The view angle are measured at HSA 10 mm.)

Product	Page	Product	Page	Product	Page	Product	Page	Product	Page	Product	Page
1103	49	1500-x	5	1599-40	18	1682-xx	27	2772-204	22	DVI-2.2 FDTS	41
1104	49	1510-2	4	1599-6004	18	1693-xxxx	40	2772-9	22	DVI-2.2 SGTS	41
1109-10	49	1510-24	5	1600	55	1697	59	2774	23	DVI-3.0 SGTS	41
1116-30	49	1510-25	35	1602-2	54	1699	59	2778-01	23	DVI-4.0 SGTS	41
1124-3	51	1510-3	4	1602-04	54	1710-xx	14	2779-01	23	DVI-Chart	56
1124-5	51	1510-34	5	1603-04	54	1711	14	2782-01	23	DVI-TSKit	41
1124-7	51	1510-41	4	1603-827	54	1740-xxx	13	2815-04	58	D-Mkit	56
1124-10	51	1510-44	5	1603-850	54	1741-103	13	2822-04	58	Mirage Telesc.	33
1130	51	1510-5	4	1604-104	54	1741-119	13	2845	58	myReader	45
1151	52	1510-54	5	1604-11	54	1752-xxx	13	2855-xx	7	SolarShields	42
1152-xx	52	15107	58	1621	35	18283	59	2872-xx	9	Solar 3s	43
1153	51	1510-7	4	1621-x	35	1848	56	2910-xx	24	UniVision	29
1154-7	52	1510-74	5	1622-5	35	1852	57	2916-xx	24		
1154-10	52	1510-10	4	1623	34	1854	10	2918-xx	24		
1163	49	1510-104	5	1623-xx	34	1855	57	4292-821	38	<b>ASH Products</b>	
1171-1	51	1510-12	4	1624-1	31	1860	57	4293-616	38	Agilo	48
1174	51	1510-124	5	1624-19	31	1860-5	57	4293-816	38	Eclipse	47
1176-xx	50	1512-9	4	1624-3	31	2031	12	4294-413	39	Eclipse Scholar	48
1177-5	50	1521-xx	6	1624-5	31	2032	12	4294-618	39	Fusion	45
1178-xx	50	1542	18	1630	34	2034	12	6949-2	54	Horizon	47
1182-10	50	1543	18	1631	40	2036	12	84158-8	39	iFlex	47
1184-10	50	1544	18	1632	37	2050-1	12	8417-3822	39	i-Qon	48
1184-20	50	1545	18	1632-x	37	2050-19	12	B1680-Kit	28	Liberty Scholar	48
1186-9	50	1546	18	1634	32	2090-04	54	B1680-xx	28	Liberty Solo	46
1187	50	1550-73	17	1634-4	32	2090-21	54	B2204-x	28	Opti Verso	48
1200-x	53	1551-73	17	1636-2	32	2090-41	54	B2702-x	28	Opti Lite	46
1254	53	1552-73	17	1636-3	32	2136-x	14	B3000-xx	29	Presto	47
1255	53	1553-93	17	1636-4	32	2605	20	B3001-Kit	29	Prisma	46
1256	53	1554-93	17	1638	33	2605	20	B6407	30	QuickLook Classic	44
1258	53	1557-73	17	1639	33	2608	20	B64076-xx-OD	30	QuickLook Focus	44
1259	53	1559-93	17	1644-504	25	2612-xx	10	B64076-xx-OS	30	QuickLook Zoom	44
1266-xx	53	1560-x	18	1645-x	25	2614-xx	11	BE-525	33	TVi Color	44
1270	53	1565-1	22	1646-xx	25	2626	51	BE-730	33		
1271	53	1565-1907	22	1647	25	2628	51	BE-731-xx	33		
1272	53	1571	6	1648-xx	25	2636-7	19	C-100	56		
1420	20	1572	6	1654-104	45	2636-11	19	C-100F	56		
1421	20	1573	6	1671-1	36	2642-xx	9	C-100S	56		
1423-1	20	1575	6	1673-xx	36	2655-xx	7	C-300	56		
1424	20	1580-63	16	1674-820	38	2668-xx	8	C-500	55		
1426	21	1582-63	16	1674-832	38	2677	23	C-1605	55		
1436	21	1585-04	19	1681-1Kit	26	2678	23	C-1605-1	55		
1436-xx	21	1591-704	18	1681-Kit OU	26	2771-104	22	C-Sim Kit	56		
1436-1907	22	1599-10	18	1681-xx	26	2772-01	22	DVI-2.2 BIO1	41		
1460-xx	21	1599-304	18	1682-2Kit	27	2772-02	22	DVI-2.2 BIO2	41		



## ■ The Eschenbach Complete Low Vision Program

The ESCHENBACH Complete Low Vision Program is a turnkey package designed specifically to enhance your patient care and increase your practice income.

ESCHENBACH will provide you with all the tools you need to successfully incorporate low vision services into your practice including:

### 1) In-Office Staff Training

Trained ESCHENBACH representatives will come to your practice to conduct extensive training for you and/or your staff on the applications of the vision aids, dispensing tips and practice management techniques.

### 2) Consultative Support

A broad range of marketing tools, patient screening and resource materials have been developed based on input from hundreds of successful low vision practices. We have also compiled the most frequently used third-party reimbursement codes for your reference.

### 3) Diagnostic System

The attractive and functional Optoform® cabinet contains a comprehensive diagnostic inventory of vision aids to meet the diverse functional needs of the visually impaired. Several standard assortments are available or we can help you develop a customized package.

Once you have enrolled in the ESCHENBACH Complete Low Vision Program, your representative will always be available to come to your office for additional training, new product updates or to answer any questions you may have.

If you're considering offering low vision care in your office, increase your odds for success by choosing Eschenbach!



## ESCHENBACH OPTIK Better vision. Better life.

Eschenbach Optik of America, Inc.

904 Ethan Allen Highway

Ridgefield, CT 06877

Phone (800) 487-5389

Fax (888) 799-7200

www.eschenbach.com

Email: info@eschenbach.com

Contact us Monday thru Friday between 8:30AM - 6:00pm EST

- ©2009 - All Rights Reserved.
- ESCHENBACH® is a Registered Trade Mark of ESCHENBACH OPTIK GmbH + Co
- ESCHENBACH® is a Registered TradeMark of ESCHENBACH OPTIK GmbH + Co
- PXM® is a Registered TradeMark of ESCHENBACH OPTIK GmbH + Co
- cera-tec® is a Registered TradeMark of ESCHENBACH OPTIK GmbH + Co
- Technical Specifications are Subject to Change

