

Instruction Manual

**8" LX90 Schmidt-Cassegrain Telescope
with Autostar Hand Controller**



Meade Instruments Corporation

The Meade Schmidt-Cassegrain Optical System

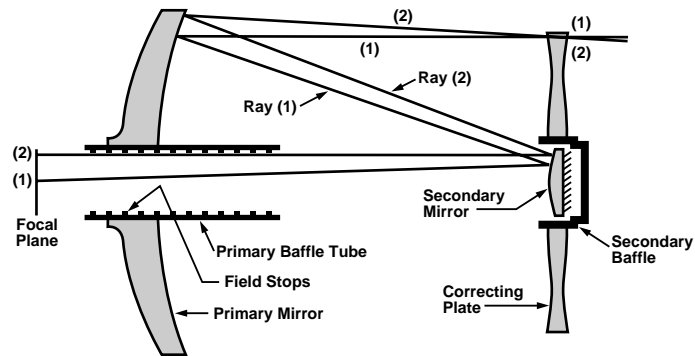

In the Schmidt-Cassegrain design of the Meade LX90, light enters from the right, passes through a thin lens with 2-sided aspheric correction ("correcting plate"), proceeds to a spherical primary mirror, and then to a convex secondary mirror. The convex secondary mirror multiplies the effective focal length of the primary mirror and results in a focus at the focal plane, with light passing through a central perforation in the primary mirror.

The Meade 8" LX90 Schmidt-Cassegrain includes an oversize primary mirror of an 8.25" diameter, yielding a fully illuminated field-of-view significantly wider than is possible with a standard-size primary mirror. Note that light ray (2) in the figure would be lost entirely, except for the oversize primary. It is this phenomenon which results in Meade Schmidt-Cassegrains having off-axis field illuminations about 10% greater, aperture-for-aperture, than other Schmidt-Cassegrains utilizing standard-size primary mirrors. Field stops machined into the inside-diameter surface of the primary mirror baffle tube significantly increase lunar, planetary, and deep-space image contrast. These field stops effectively block off-axis stray light rays.

© The name "Meade" and the Meade logo are trademarks registered with the U.S. Patent Office and in principal countries throughout the world. "LX90" is a trademark of Meade Instruments Corporation.

© 2000 Meade Instruments Corporation.



WARNING!

Never use a Meade® LX90 Telescope to look at the Sun! Looking at or near the Sun will cause instant and irreversible damage to your eye. Eye damage is often painless, so there is no warning to the observer that damage has occurred until it is too late. Do not point the telescope or its viewfinder at or near the Sun. Do not look through the telescope or its viewfinder as it is moving. Children should always have adult supervision while observing.

CAUTION: Use care to install batteries in the orientation indicated by illustration in the battery slots of the battery holder. Follow battery manufacturer's precautions. Do not install batteries backwards or mix new and used batteries. Do not mix battery types. If these precautions are not followed, batteries may explode, catch fire, or leak. Improperly installed batteries void your Meade warranty.

If you are anxious to use your telescope for the first time, read the QUICK-START GUIDE on pages 4 and 5.

CONTENTS

Quick-Start Guide	4
Telescope Features	6
Autostar Features	9
Getting Started	12
Parts Listing	12
How to Attach the Tripod to the Telescope	12
How to Assemble Your Telescope	12
Choosing an Eyepiece	14
Mounting and Adjusting the Viewfinder	14
Observing	15
Observing By Moving the Telescope Manually	15
Terrestrial Observing	15
Observing Using Autostar's Arrow Keys	15
Slew Speeds	16
Observe the Moon	16
Astronomical Observing	17
To Track an Object Automatically	17
Alt/Az Home Position	17
Moving Through Autostar's Menus	17
Initializing Autostar	17
Observe a Star Using Automatic Tracking	18
Easy (Two-Star) Align	19
Go To Saturn	20
Using the Guided Tour	20
Basic Autostar Operation	21
Autostar Navigation Exercise	21
Entering Data into Autostar	22
Navigating Autostar	22
Menus and Menu Options	23
Complete Autostar Menu Structure	23
Objects Menu	23
Event Menu	24
Glossary Menu	25
Utilities Menu	25
Setup Menu	26
Advanced Autostar Features	29
Adding Observing Sites	29
Finding Objects Not in the Database	30
Observing Satellites	31
How to Create Your Own Guided Tour	32
Landmarks	35
Identify	36
Advanced Alt/Az Alignment	37
Browse	37
Photography with the LX90	38
Optional Accessories	39
Maintenance	41
Collimation	41
Inspecting the Optics	43
Gauging the Movement of the Telescope	43
Meade Customer Service	43
Specifications	44
Appendix A: Equatorial (Polar) Alignment	45
Appendix B: Helpful Charts	48
Appendix C: Training the Drive	49
Basic Astronomy	50
A Roadmap to the Stars	52

QUICK-START GUIDE

It is recommended that you attach the supplied tripod to the LX90 for observing. Perform the telescope and Autostar setup indoors in the light so that you become familiar with the parts and operation before moving the telescope outside into the dark for observing.



1. Remove the field tripod from the shipping carton. Stand the tripod vertically with the tripod feet down and with the tripod still fully collapsed. Grasp two of the tripod legs and, with the full weight of the tripod on the third leg, gently pull the legs apart to a fully open position.



2. Thread in two lock-knobs on each leg (six total) near the foot of each tripod leg. Use the lock-knobs to vary the height of the inner, extendible tripod leg sections. Tighten the locks to a firm feel only; do not overtighten.

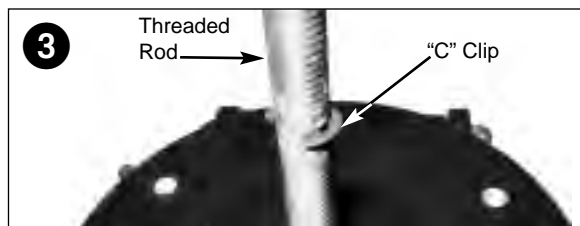

3. Remove the threaded rod (see above figure) from the tripod head. A small piece of plastic holds the threaded rod in place. Remove the small plastic bag that is stapled to the threaded rod. This bag contains the "C" clip retainer and an extra clip.



4. Remove the spreader bar (see above figure) from the shipping carton. Slide the spreader bar onto the threaded rod and position the rod back through the tripod head. Place the "C" clip into the slot in the threaded rod – this clip holds the threaded rod in place. Position the spreader bar so that its three arms line up with the three tripod legs.



5. Take the LX90 from its packaging and place the entire telescope onto the top of the tripod head, inserting the threaded rod into the central hole in the bottom of the drive base of the telescope. Tighten the tension knob (see above figure) to a firm feel only; firm tightening of the tension knob is sufficient to result in rigid positioning of the tripod legs.

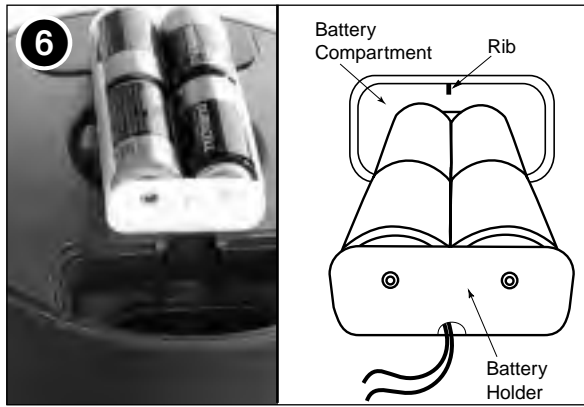

6. Remove the covers from both battery compartments located on top of the drive base and carefully lift the battery holders from their compartments, being mindful of the connector wires. Insert four (user-supplied) C-cell batteries into each battery holder (eight batteries total), oriented as shown on the diagram on the battery holder.

Return the battery holders to the battery compartment. See the diagram above. Replace the covers when you are done.

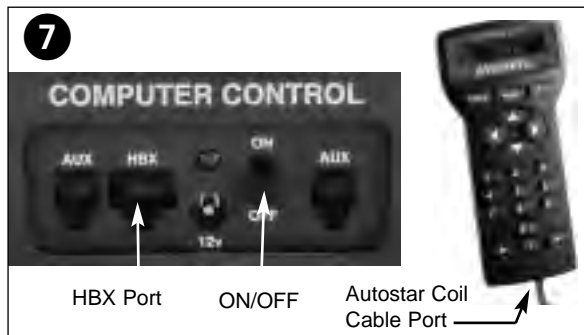

7. Slide the computer control panel power switch to OFF, if necessary. Remove the Autostar handbox and the Autostar interface cable from the packing materials. Plug one end into the HBX port of the computer control panel and plug the other end into the Coil Cable port on the Autostar handbox.



8. Flip the Power Switch on the computer control panel to the ON position. The copyright message lights on Autostar's LCD display.

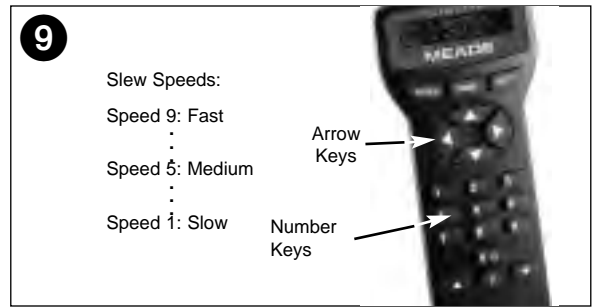

9. Press the key prompted by Autostar to accept the Sun warning. You can now use the Arrow keys to slew (move) the telescope up, down, right, or left. To change the telescope's slew speed, press the Number keys. "9" is the fastest speed and "1" is slowest speed. See page 16 for more details.

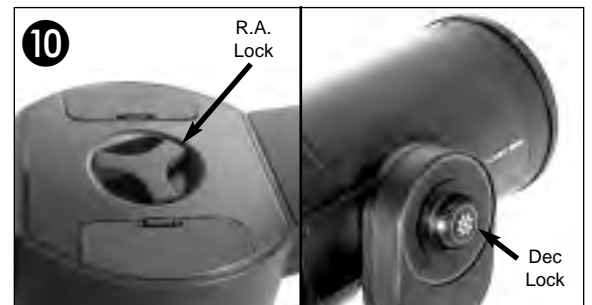

10. Tighten, to a firm feel only, the Dec and R.A. locks (6 and 9, Fig. 1). See page 7 for more information. Remove the dust cover from the end of the telescope tube.

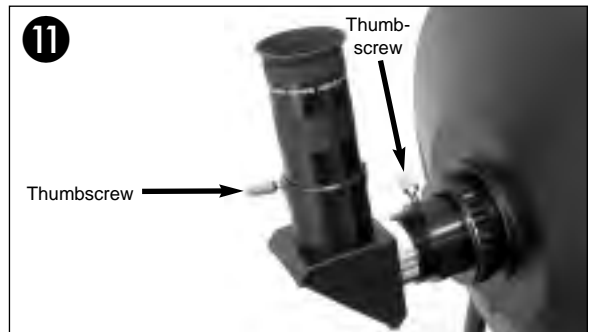

11. Remove the dust cap from the rear cell of the telescope. Thread the eyepiece holder into the rear cell thread. Slide the diagonal prism into the eyepiece holder and lock in place by turning the thumbscrew to a firm feel.

Place the Super Plössl 26mm eyepiece into the diagonal prism and tighten the attachment thumbscrew to a firm feel only.

Sight along the side of the telescope's main tube to locate an object. Use the telescope's focus knob (8, Fig. 1) to bring the object into focus. Practice using the Autostar's Arrow keys to center an object in the telescope's field of view.

TELESCOPE FEATURES

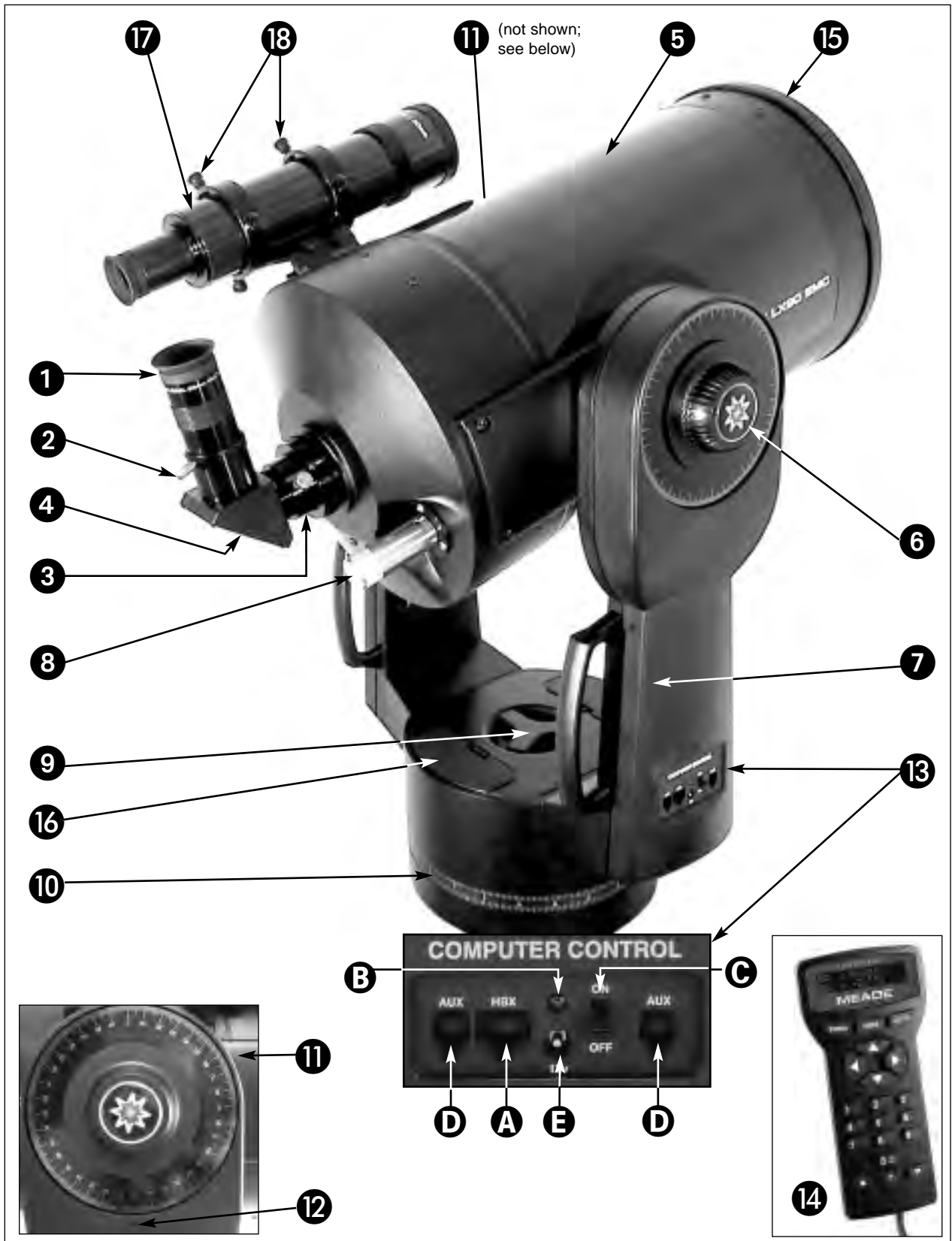

Fig. 1: The LX90 Telescope and Autostar Handbox.

LX90: Your Personal Window to the Universe

The Meade LX90 is an extremely versatile, high-resolution telescopes with features similar to those available only with larger and more specialized imaging systems. With pushbutton controls, automatic tracking of celestial objects, and software downloading capability, the LX90 telescope may be all the telescope ever required by many terrestrial and astronomical observers.

Your LX90 telescope reveals nature in an ever-expanding level of detail. Observe the feather structure of an eagle from 50 yards or study the rings of the planet Saturn from a distance of 800 million miles. Focus beyond the Solar System and observe majestic nebulae, ancient star clusters, remote galaxies, and even stars recently discovered to have planets orbiting about them. Meade LX90 telescopes are instruments fully capable of growing with your interest and are ideal for both the casual observer and serious astronomer alike.

CAUTION:

Using products other than standard Meade accessories may cause damage to the telescope's internal electronics and may void the Meade warranty.

- ❶ **Eyepiece** - Place the Super Plössl 26mm eyepiece into the eyepiece holder or 90° diagonal prism (4, Fig. 1) and tighten in place with the thumbscrews. The eyepiece magnifies the image collected in the optical tube.
- ❷ **Eyepiece Holder Thumbscrew** - Tightens the eyepiece in place. Tighten to a firm feel only.
- ❸ **Eyepiece Holder** - Holds the eyepiece in place
- ❹ **Diagonal Prism** - provides a more comfortable right angle viewing position. Slide the diagonal prism directly into the eyepiece holder (3, Fig. 1)
- ❺ **Optical Tube** - The main optical component that gathers the light from distant objects and brings this light to a focus for examination through the eyepiece.
- ❻ **Dec Lock** - Controls the manual vertical movement of the telescope. Turning the Dec lock counterclockwise unlocks the telescope enabling it to be freely rotated by hand about the vertical axis. Turning the Dec lock clockwise (to a firm feel only) prevents the telescope from being moved manually, but engages the vertical motor drive for Autostar operation.
NOTE: The Dec lock knob is a knurled knob located on the fork arm to the right of the focus knob (8, Fig. 1).
CAUTION: When loosening the Dec lock, be sure to support the optical tube (5, Fig. 1). The weight of the tube could cause the tube to swing through the fork arms suddenly.
- ❼ **Fork Arms** - Hold the optical tube in place.
- ❽ **Focus Knob** - Moves the telescope's primary mirror in a finely-controlled motion to achieve precise image focus. The LX90 telescope can be focused on objects from a distance of about 25 ft. to infinity. Rotate the focus knob counterclockwise to focus on distant objects, and clockwise to focus on nearby objects.
- ❾ **R.A. Lock** - Controls the manual horizontal rotation of the telescope. Turning the R.A. lock counterclockwise unlocks the telescope, enabling it to be freely rotated by hand about the horizontal axis. Turning the R.A. lock clockwise prevents the telescope from being rotated manually, and engages the horizontal motor drive for Autostar operation.
- ❿ **Right Ascension (R.A.) Setting Circle** - See "APPENDIX A," page 45, for detailed information.
- ⓫ **Declination (Dec) Setting Circle** (on left fork arm) - See "APPENDIX A," page 45, for detailed information.
- ⓬ **Declination Pointer** - Line up the desired Declination setting with this pointer.

- 13 Computer Control Panel**
- A. Handbox (HBX) Port** - Plug the Autostar coil cord (**10, Fig. 2**) into this port.
 - B. LED** - The red power indicator light illuminates when power is supplied to the Autostar handbox and to the telescope's motor drive.
 - C. ON/OFF Switch** - Turns the Computer Control Panel and Autostar ON or OFF.
 - D. Auxiliary (AUX) Port (2)** - Provides connection for current and future Meade accessories, such as the Meade Accessory Port Module. See "OPTIONAL ACCESSORIES," page 39.
 - E. 12v Power Connector** - provides connection so that the telescope assembly may be powered from either a 12v DC auto cigarette light plug or from a standard 115v AC home outlet using optionally available 25' power cords.
- 14 Autostar** with coil cord - See page 9 for a description of Autostar's features.
- 15 Dust Cover**- Gently pry the dust cover from the front lens of the telescope.
- NOTE:** The dust cover should be replaced after each observing session and the power turned off to the telescope. Verify that any dew that might have collected during the observing session has evaporated prior to replacing the dust cover.*
- 16 Battery Compartments** - Insert four (user-supplied) C-cell batteries in each compartment (eight batteries total).
- 17 Viewfinder** - A low-power, wide-field sighting scope with crosshairs that enable easy centering of objects in the telescope eyepiece.
- 18 Viewfinder Collimation Screws** - Use these screws to adjust the alignment of the viewfinder. See "Mounting and Adjusting the Viewfinder," page 14.

AUTOSTAR FEATURES

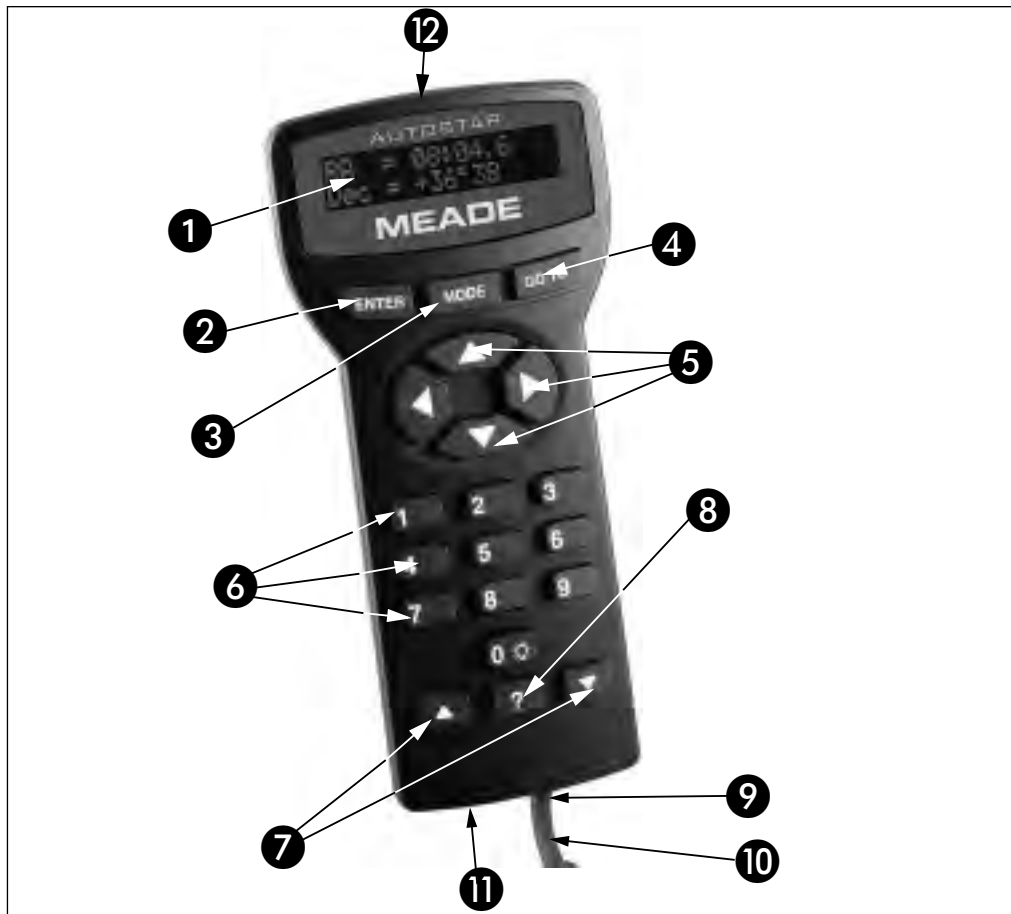

Fig. 2: The LX90 Autostar Handbox.

Tour the Cosmos with Just the Push of a Button

Control of the LX90 is through the operation of the standard-equipment Autostar. Nearly all functions of the telescope are accomplished with just a few pushes of Autostar's buttons. Some of the major features of Autostar are:

- Automatically move the telescope to any of over 30,000 objects stored in the database or manually enter the astronomical coordinates of any celestial object.
- Take a guided tour of the best celestial objects to view on any given night of the year.
- Download the latest satellite data and software revisions directly from the Meade website (www.meade.com) and share software with other Autostar enthusiasts. (Requires optional #505 AstroFinder™ Software and Cable Connector Kit. See "OPTIONAL ACCESSORIES," page 39.)
- Control your LX90 with your PC using an RS-232 interface.
- Access a glossary of astronomical terms.
- Calculate which eyepiece to use for optimum viewing of a celestial object.
- Mount the telescope in the "Alt/Az" mode (Altitude - Azimuth, or vertical - horizontal) for fully automatic tracking of celestial objects.
- Extensive long-exposure astrophotography and CCD imaging capability is available when the LX90 is mounted in the "Equatorial" (Polar) mode using an optional mounting wedge.

The Autostar Computer Controller provides control of virtually every telescope function within a compact handbox. Autostar has soft-touch keys designed to have a positive feel. The LCD (Liquid Crystal Display) is backlit with a red LED (Light Emitting Diode) for easy viewing in the dark. The backlit display, key arrangement, and sequential database make Autostar extremely user friendly.

NOTE: Autostar does not require batteries; the telescope's batteries supply power to Autostar.

NOTE:

Throughout this manual, you will notice the term "Alt/Az." Alt/Az is frequently used to refer to Altitude (vertical) and Azimuth (horizontal). Alt/Az is just one of many methods used by amateur astronomers to help locate stars in the night sky.

TIP:

To manually enter the R.A. and Dec coordinates of an object:

Press and hold MODE for two seconds or more. The R.A. and Dec coordinates display. Press GO TO. "Object Position" and a set of coordinates displays. Then enter the R.A. and Dec coordinates of any celestial object using Number keys. As soon as the coordinates are entered, Autostar slews the telescope to the coordinates. Note that the telescope must be initialized (see page 17) and placed in the Home position (see page 17) for this procedure to operate properly.

- 1 **2-Line LCD Display** - Provides an interface between Autostar and the telescope.
 - **Top line:** Lists the primary category or menu item.
 - **Bottom line:** Contains a menu option or information about an object or subject, depending on which function is being performed.
- 2 **ENTER Key** - Accesses, in a sequential manner, the next menu or data level in the Autostar database. See "MOVING THROUGH AUTOSTAR'S MENUS," page 17 and "AUTOSTAR'S MENU AND MENU OPTION DESCRIPTIONS," page 23.

NOTE: If ENTER is pressed for two seconds or more and then released, Autostar emits a beep and "ENTER to Sync" is displayed. "ENTER to Sync" is relevant only after the telescope has been aligned and is pointing at an object. If the "ENTER to Sync" feature is accessed by mistake, press MODE to return to the previous screen. See "HIGH PRECISION," page 27, for more details about this feature.
- 3 **MODE Key** - Returns to the previous menu or data level in the Autostar database until the top level, "Select Item," is reached. The MODE key is similar to the ESCAPE key on a computer.

NOTE: Pressing MODE while in the "Select Item" level moves Autostar to the top-most screen: "Select Item: Object."

NOTE: If MODE is pressed and held for two seconds or more, information about the telescope's status is then available using the Scroll keys (7, Fig. 2), such as:

 - Right Ascension and Declination (astronomical) coordinates (see page 45)
 - Altitude (vertical) and Azimuth (horizontal) coordinates
 - Local Time and Local Sidereal Time (LST)
 - Timer and Alarm Status
 - Accessory Port Module (APM) status. Information concerning these functions are described on the instruction sheets supplied with the APM.

Press MODE again to return to the previous menu.
- 4 **GO TO Key** - Slews (moves) the telescope to the coordinates of the currently selected object. While the telescope is slewing, the operation may be aborted at any time by pressing any key except GO TO. Pressing GO TO again resumes the slew to the object.
- 5 **Arrow Keys** - Slew the telescope in a specific direction (up, down, left, and right), at any one of nine different speeds. Speed selection is explained in "SLEW SPEEDS," page 16. The following functions are also available with the Arrow keys:
 - **Data Entry** - Use the Up and Down Arrow keys to scroll through the letters of the alphabet and numerical digits. The Down Arrow key starts with the letter "A" and the Up Arrow key starts with the digit "9." The Left and Right Arrow keys are used to move the blinking cursor left and right across the LCD display.
 - **Alt/Az Alignment** - Use the Up and Down Arrow keys to move the telescope vertically up and down. The Left Arrow key rotates the telescope horizontally counterclockwise, while the Right Arrow key rotates it clockwise.
- 6 **Number Keys** - Input digits 0 - 9 and changes the slew speeds (see "SLEW SPEEDS," page 16). The "0" key also turns on and off the red utility light on the top of the handbox.

- 7 Scroll Keys** - Accesses database options within a selected menu. The menu is displayed on the first line of the screen. Options within the menu are displayed, one at a time, on the second line. Press the Scroll keys to move through the options. Press and hold a Scroll key to move quickly through the options.

The Scroll keys also scroll through the letters of the alphabet and numerical digits.

***NOTE:** The Scroll Down key and the Down Arrow key move forward through the alphabet & digits (A to Z, 0 to 9). The Scroll Up key and the Up Arrow key move backward (Z to A, 9 to 0). Common symbols are also available in the list.*

- 8 ? Key** - Accesses the "Help" file. "Help" provides on-screen information on how to accomplish whatever task is currently active.

Hold down the ? key and then follow the prompts on the display to access details of Autostar functions in the Help feature. The Help system is essentially an on-screen instruction manual.

If you have a question about an Autostar operation, e.g., INITIALIZATION, ALIGNMENT, etc., hold down the ? key and follow the directions that scroll on the second line of the LCD screen. When a word appears in **[brackets]**, press ENTER to access the Autostar Glossary. A definition or more detailed information is displayed. Press MODE to return to the scrolling Autostar Help display.

When satisfied with the Help provided, press MODE to return to the original screen and continue with the chosen procedure.

- 9 Coil Cord Port** - Plug one end of the Autostar coil cord into this port (**11, Fig. 2**) located at the bottom of the Autostar handbox.

- 10 Coil Cord** - Plug one end of the Autostar coil cord into the HBX port (**13A, Fig. 1**) of the computer control panel of the telescope.

- 11 RS-232 Port** - plug an RS-232 cable into Autostar for downloading functions such as "Download" or "Clone." See page 28 for more details.

- 12 Utility Light** - Use this built-in red light to illuminate star charts and accessories without disturbing your eye's adaptation to darkness.



Join an Astronomy Club
Attend a Star Party

One of the fun ways to learn about astronomy is to join an astronomy club. Check your local newspaper, school, library, or telescope dealer/store to find out if there's a club in your area.

At club meetings, you will meet other astronomy enthusiasts with whom you will be able to share your discoveries. Clubs are an excellent way to learn more about observing the sky, to find out where the best observing sites are, and to compare notes about telescopes, eyepieces, filters, tripods, and so forth.

Often, club members are excellent astrophotographers. Not only will you be able to see examples of their art, but you may even be able to pick up some "tricks of the trade" to try out on your LX90 telescope. See page 38 for more information about photography with the LX90.

Many groups also hold regularly scheduled Star Parties at which you can check out and observe with many different telescopes and other pieces of astronomical equipment. Magazines such as *Sky & Telescope* and *Astronomy* print schedules for many popular Star Parties around the United States and Canada.

GETTING STARTED

Parts Listing

Getting the telescope ready for first observations requires only a few minutes. When first opening the packing box, note carefully the following parts:

- LX90 Telescope with fork mount system
- Autostar handbox and interface coil cord
- 8 x 50mm viewfinder assembly
- Eyepiece holder and 1.25 diagonal prism
- Super Plössl 26mm eyepiece, packed in a plastic storage container
- Variable height tripod and mounting base
- Set of hex wrenches

How to Attach the Tripod to the Telescope Assembly

The telescope's fork mount attaches directly to the field tripod. The telescope in this way is mounted in an "Altazimuth" ("Altitude-Azimuth," or "vertical-horizontal") format. The telescope in this configuration moves along vertical and horizontal axes, corresponding respectively to the Declination (vertical) and Right Ascension (horizontal) axes in an astronomical observing mode.

The field tripod also can be used in conjunction with the optional equatorial wedge (see "EQUATORIAL WEDGE," page 47) for long exposure astrophotography. The equatorial wedge permits alignment of the telescope's Polar Axis with the Celestial Pole (or North Star).

1. After removing the field tripod from its shipping carton, stand the tripod vertically, with the tripod feet down and with the tripod still fully collapsed (see Fig. 3). Grasp two of the tripod legs and, with the full weight of the tripod on the third leg, gently pull the legs apart to a fully open position.
2. Thread in the 6 lock-knobs (2 on each tripod leg) near the foot of each tripod leg (Fig. 3). These lock-knobs are used to fix the height of the inner, extendible tripod leg sections.

NOTE: Tightening to a firm-feel is sufficient; over-tightening may result in stripping of the knob threads or damage to the tripod legs and results in no additional strength.

3. The spreader bar (4, Fig. 3) has been removed for shipment. To install, first remove the threaded rod (2, Fig.3) from the tripod head (1, Fig. 3); a small piece of plastic holds the threaded rod in place. Remove the small plastic bag that is stapled to the threaded rod. This bag contains the "C" clip retainer and an extra clip.
4. Slide the spreader bar onto the threaded rod (note the correct orientation as shown in Fig. 4) and position the threaded rod back through the tripod head. Place the clip retainer (a "C" clip) into the slot in the threaded rod. This clip holds the threaded rod in place. See Fig. 3.

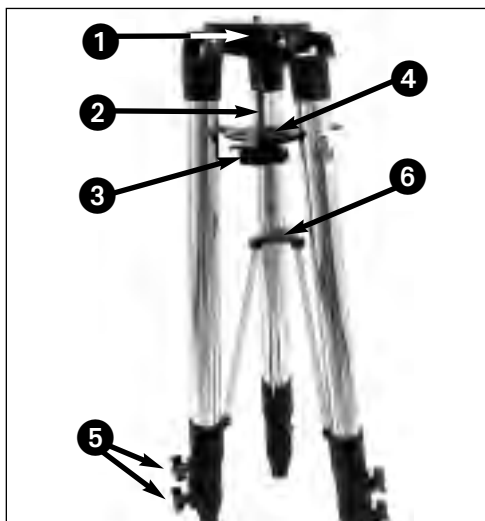

Fig. 3: Field Tripod. (1) Tripod Head; (2) Threaded Rod; (3) Tension Knob; (4) Spreader Bar; (5) Lock Knobs;



Fig. 4: Attaching the telescope to the tripod. Note the orientation of the spreader bar.

5. Position the spreader bar so that the 3 arms of the spreader bar line up with the 3 tripod legs.
6. Place the entire telescope onto the top of the tripod head, and insert the threaded rod into the central hole in the bottom of the drive base of the telescope. Tighten the tension knob (**3, Fig. 3**); firm tightening of the tension knob is sufficient to result in rigid positioning of the tripod legs.
7. To vary the tripod height, loosen the 6 lock-knobs, slide the 3 inner tripod leg sections out to the desired height, and firmly re-tighten (but do not overtighten) the 6 lock-knobs.

To collapse the tripod (after removing the telescope and equatorial wedge, if applicable) for storage follow these steps:

1. Rotate the spreader bar 60° from its assembled position, so that one spreader bar arm is located between each adjacent pair of tripod legs.
2. At the base of the tripod is a 3-vane extension strut system, with a circular hub at its center (**6, Fig. 3**). Grasp the tripod head (**1, Fig. 3**) with one hand and, with the other hand, pull directly “up” on the central hub of the extension strut system. This operation will cause the tripod legs to move inward to a collapsed position.

Precautionary Notes

- If the tripod does not seem to extend or collapse easily, do not force the tripod legs in or out. By following the instructions above, the tripod will function properly, but if you are unclear on the proper procedure, forcing the tripod into an incorrect position may damage the extension strut system.
- Do not overtighten the 6 lock-knobs used to fix the inner tripod leg sections at various heights. Tighten to a firm feel only.
- Be sure the spreader bar (**4, Fig. 3**) is not upside-down on the threaded rod.

How to Assemble Your Telescope

Assembly of the LX90 telescope requires eight C-cell (user-supplied) batteries or optional power cords (25') to a standard 115v home outlet or to a 12v DC automobile cigarette lighter plug. See the Instruction Sheets supplied with the optional power cords for installation information. To install batteries:

1. Unlock the Dec lock (**6, Fig. 1**) to move the optical tube (**5, Fig. 1**) through the fork arms. Move the optical tube to the position depicted in **Fig. 1** and relock the Dec lock.
2. Remove the battery compartment covers (**16, Fig. 1**) and carefully remove the battery holder, being mindful of the connector wires. Insert four C-cell batteries into each battery holder, oriented as shown on the diagram on the battery slots inside the battery holder. Return the battery holders to their respective compartments and replace the covers.

See Fig. 5 for the proper orientation of the holder. Do not force the holder into the battery compartment. If a holder does not slip easily into the compartment, you may have inserted the holder incorrectly. Replace the compartment covers when you are done.

CAUTION: Use care to install batteries as indicated by the battery compartment. Follow battery manufacturer's precautions. Do not install batteries backwards or mix new and used batteries. Do not mix battery types. If these precautions are not followed, batteries may explode, catch fire, or leak. Improperly installed batteries void your Meade warranty. Always remove the batteries if they are not to be used for a long period of time.

3. Be certain that the power switch on the computer control panel (**13C, Fig. 1**) is in the OFF position. Plug the coil cord of the Autostar Controller into the HBX port (**13A, Fig. 1**).

NOTE: Autostar does not require batteries; the telescope's batteries supply power to Autostar.

4. Remove the dust cap from the rear cell of the telescope. Thread the eyepiece holder into the rear cell thread. Slide the diagonal prism into the eyepiece holder and lock in place by turning the thumbscrew to a firm feel.
5. Remove the Super Plössl 26mm eyepiece (**1, Fig. 1**) from its container and place it in the diagonal prism (**3, Fig. 1**). Tighten the thumbscrew (**2, Fig. 1**) to a firm feel only.
6. Remove the dust cover (**15, Fig. 1**) from the optical tube assembly (**5, Fig. 1**) by gently prying it off.

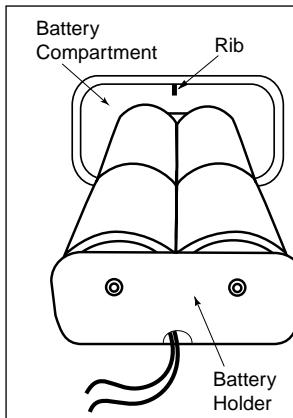

Fig. 5: Four C-cell batteries mounted inside one of the battery holders. Note position of rib in the battery compartment.

Choosing an Eyepiece

A telescope's eyepiece magnifies the image formed by the telescope's main optics. Each eyepiece has a focal length, expressed in millimeters, or "mm." The smaller the focal length, the higher the magnification. For example, an eyepiece with a focal length of 9mm has a higher magnification than an eyepiece with a focal length of 26mm.

NEVER point the telescope directly at or near the Sun at any time! Observing the Sun, even for the smallest fraction of a second, will result in instant and irreversible eye damage, as well as physical damage to the telescope itself.

Your telescope comes supplied with a Super Plössl 26mm eyepiece which gives a wide, comfortable field of view with high image resolution.

Low power eyepieces offer a wide field of view, bright, high-contrast images, and eye relief during long observing sessions. To find an object with a telescope, always start with a lower power eyepiece such as the Super Plössl 26mm. When the object is located and centered in the eyepiece, you may wish to switch to a higher power eyepiece to enlarge the image as much as practical for prevailing seeing conditions. For information about optional eyepieces for the LX90, see "OPTIONAL ACCESSORIES," page 39.

NOTE: Seeing conditions vary widely from night-to-night and site-to-site. Turbulence in the air, even on an apparently clear night, can distort images. If an image appears fuzzy and ill-defined, back off to a lower power eyepiece for a more well-resolved image (**Fig. 7a and 7b**).

The power, or magnification of a telescope is determined by the focal length of the telescope and the focal length of the eyepiece being used. To calculate eyepiece power, divide the telescope's focal length by the eyepiece's focal length. For example, a 26mm eyepiece is supplied with the LX90. The focal length of the LX90 is 2000mm (see "Specifications," page 44).

$$\text{Eyepiece Power} = \frac{\text{Telescope Focal Length}}{\text{Eyepiece Focal Length}} = \frac{2000\text{mm}}{26\text{mm}} = 77X$$

The eyepiece power, or magnification is therefore 77X (approximately).

Mounting and Adjusting the Viewfinder

To align the viewfinder, perform steps 1 through 5 during the daytime; perform step 6 at night.

1. Slide the track on the bottom of the viewfinder into the slot in the viewfinder mounting assembly. See **Fig. 6a**. To secure the viewfinder to the mounting assembly, tighten the two thumbscrews (**Fig. 6a**) to a firm feel only.
2. If you have not already done so, insert the Super Plössl 26mm eyepiece into the diagonal prism.
3. Unlock the R.A. (**9, Fig. 1**) and Dec (**6, Fig. 1**) locks so that the telescope moves freely on both axes.
4. Point the telescope at some well-defined and stationary land object at least 200 yards distant, such as the top of a telephone pole or street sign. Center the object in the telescope eyepiece. Re-tighten the R.A. and Dec locks.
5. Look through the viewfinder eyepiece (**Fig. 6b**) and loosen or tighten, as appropriate, one or more of the viewfinder collimation screws (**Fig. 6b**) until the viewfinder crosshairs are precisely centered on the object you previously centered in the telescope eyepiece.
6. Check this alignment on a celestial object, such as the Moon or a bright star, and make any necessary refinements, using the method outlined in steps 3 and 4.

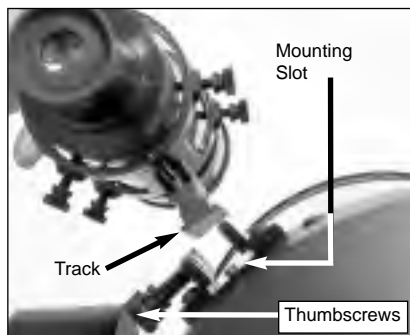

Fig. 6a: Viewfinder Assembly.

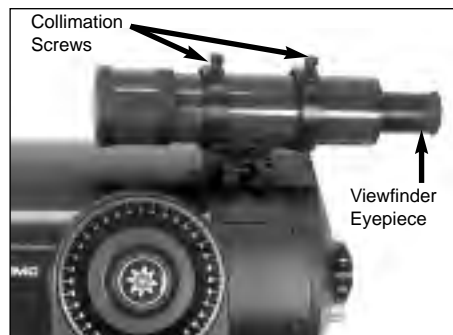

Fig. 6b: Viewfinder Assembly.

NOTE:

For a list of magnification ratings of the eyepieces available for the LX90 telescope, see "OPTIONAL ACCESSORIES," page 39.

OBSERVING

IMPORTANT NOTE:

Objects appear upside-down and reversed left-for-right when observed in the viewfinder and also in the eyepiece when inserted directly into the (straight-through) eyepiece holder – with the diagonal prism in place, images will be right-side-up, but reversed left-for-right.

This image inversion is of no consequence when observing astronomical objects and, in fact, all astronomical telescopes yield inverted images.

During terrestrial observing, where a fully-correctly-oriented image (right-side-up and correct left-for-right) is desirable, an optional #928 45° Erecting Prism is available. See "OPTIONAL ACCESSORIES," page 39.

Observing By Moving the Telescope Manually

If you wish to observe a distant land object, such as a mountain top or a bird, you can observe by merely pointing the telescope and looking through the eyepiece.

1. Loosen the telescope's R.A. lock (9, Fig. 1) and Dec lock (6, Fig. 1).
2. Move your telescope to observe distant street signs, mountains, trees, and other structures. Use your viewfinder to help site-in on an object.
3. Center the object in the viewfinder's crosshairs and then in the telescope eyepiece. When the object is centered in your eyepiece, remember to re-tighten the R.A. and Dec locks.
4. Practice focusing objects with the focus knob (8, Fig. 1).
5. Once you get a feel for how your telescope moves and focuses, try to view something more challenging, like a bird or a distant moving train.

NOTE: Viewing conditions vary widely from night-to-night and site-to-site. Turbulence in the air, even on an apparently clear night, can distort images. Low-power eyepieces, such as the Super Plössl 26mm supplied with your telescope, are better suited to resolving images in poor viewing conditions.

You can also observe stars and objects in the night sky using this method, but note that objects begin to slowly drift across the eyepiece field. This motion is caused by the rotation of the Earth. As you become familiar with the Autostar handbox operation, you can counteract the drift using the automatic tracking feature in the Autostar Setup menu (see "TO TRACK AN OBJECT AUTOMATICALLY," page 18), or by using Autostar's GO TO capabilities (see "GO TO SATURN," page 20).

Terrestrial Observing

The LX90 is an excellent high-resolution, terrestrial (land) telescopes. Viewing terrestrial objects requires looking along the Earth's surface through heat waves. These heat waves often cause degradation of image quality. Lower power eyepieces, like the Super Plössl 26mm eyepiece, magnify these heat waves less than higher power eyepieces. Therefore, lower power eyepieces provide a steadier, higher quality image. If the image is fuzzy or ill-defined, reduce to a lower power eyepiece, where the heat waves do not have such an effect on image quality. Observing in early morning hours, before the ground has built up internal heat, produces better viewing conditions than during late afternoon hours.

Observing Using Autostar's Arrow Keys

You may observe land and astronomical objects using Autostar's Arrow keys to move the telescope.

1. Make sure that the Dec and R.A. locks (6 and 9, Fig. 1) are secured as described on page 5.
2. Verify that Autostar is properly connected to your telescope. See "HOW TO ASSEMBLE YOUR TELESCOPE," page 13.

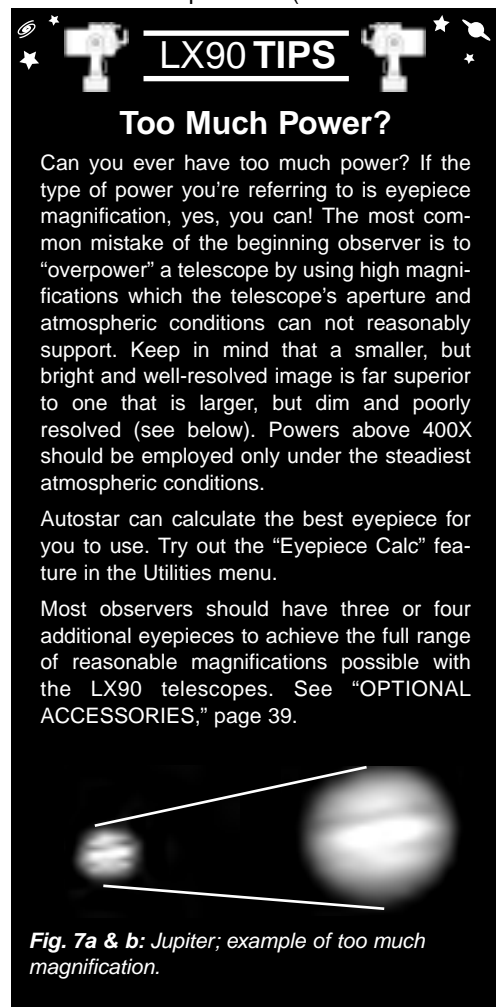

3. Flip the telescope power switch to the ON position.
The Autostar screen is activated and a copyright message displays briefly, followed by a short beep. Then Autostar takes a few moments to start up the system.
4. A message displays that warns not to look at the Sun. At the end of this message, press the key prompted by Autostar to signify that the message has been read and understood.
5. The Arrow keys are now activated. Press the Arrow keys (**5, Fig. 2**) to slew (move) the telescope up, down, right, or left.
6. Press a Number key (**8, Fig. 2**) to change the telescope's slew speed. See "SLEW SPEEDS," below, for more information.
7. Use the viewfinder (**17, Fig. 1**) to locate an object and practice using the Autostar's Arrow keys to center the object in the telescope's field of view.
8. Use the telescope's focus knob (**8, Fig. 1**) to bring the object into focus.

Slew Speeds

Autostar has nine slew speeds that are directly proportional to the sidereal rate and have been calculated to accomplish specific functions. Pressing a Number key changes the slew speed, which is shown for about two seconds on Autostar's display.

The nine available speeds are:

Number Key 1 =	1x =	1 x sidereal (0.25 arc-min/sec or 0.004°/sec)
Number Key 2 =	2x =	2 x sidereal (0.5 arc-min/sec or 0.008°/sec)
Number Key 3 =	8x =	8 x sidereal (2 arc-min/sec or 0.033°/sec)
Number Key 4 =	16x =	16 x sidereal (4 arc-min/sec or 0.067°/sec)
Number Key 5 =	64x =	64 x sidereal (16 arc-min/sec or 0.27°/sec)
Number Key 6 =	128x =	32 arc-min/sec or 0.5°/sec
Number Key 7 =	1.5° =	90 arc-min/sec or 1.5°/sec
Number Key 8 =	3° =	180 arc-min/sec or 3°/sec
Number Key 9 =	Max =	390 arc-min/sec or 6.5°/sec)

Speeds 1, 2, or 3: Best used for fine centering of an object in the field of view of a higher power eyepiece, such as a 12mm or a 9mm eyepiece.

Speeds 4, 5, or 6: Enables centering an object in the field of a low-to-moderate power eyepiece, such as the standard Super Plössl 26mm.

Speeds 7 or 8: Best used for rough centering of an object in the eyepiece.

Speed 9: Moves the telescope quickly from one point in the sky to another

NOTE:

Do not look through the telescope's eyepiece or viewfinder while it is rapidly moving. Children should always have adult supervision while observing.

Observe the Moon

Point your telescope at the Moon (note that the Moon is not visible every night) and practice using the Arrow keys and the slew speeds to view different features. The Moon contains many interesting features, including craters, mountain ranges, and fault lines. The best time to view the Moon is during its crescent or half phase. Sunlight strikes the Moon at an angle during these periods and adds a depth to the view. No shadows are seen during a full Moon, causing the overly bright surface to appear flat and rather uninteresting. Consider the use of a neutral density Moon filter when observing the Moon. Not only does it cut down the Moon's bright glare, but it also enhances contrast, providing a more dramatic image.

Astronomical Observing

Used as an astronomical instrument, your telescope has many optical and electromechanical capabilities. It is in astronomical applications where the high level of optical performance is readily visible. The range of observable astronomical objects is, with minor qualification, limited only by the observer's motivation.

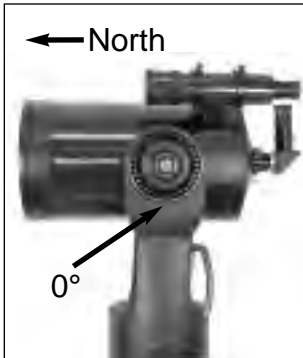

Fig. 8: Alt/Az Home Position.

To Track an Object Automatically

As the Earth rotates beneath the night sky, the stars appear to move from East to West. The speed at which the stars move is called the sidereal rate. You can setup your telescope to move at the sidereal rate so that it automatically tracks the stars and other objects in the night sky. If the telescope is not tracking an astronomical object, the object will drift out of the eyepiece field of view. The tracking function automatically keeps an object more or less centered in the telescope's eyepiece.

To automatically track objects, you must first set the telescope in the home position, then initialize Autostar, and finally select "Targets: Astronomical" from the Autostar Setup menu. You must also learn how the Autostar keypad operates in order to move through the Autostar menus.

The "Alt/Az" Home Position

1. Loosen the telescope's Dec lock (**6, Fig. 1**).
2. Level the tripod head (**1, Fig.3**). Level the optical tube by lining up 0° on the Dec setting circle (**11, Fig. 1**) with the Dec pointer (**12, Fig. 1**).
3. Tighten the Dec lock (**6, Fig. 1**) to a firm feel only.
4. Unlock the R.A. lock (**9, Fig. 1**) and turn the telescope horizontally until it points North. See "LOCATING POLARIS," page 46 for more information.
5. Re-lock the R.A. lock (**9, Fig. 1**). Press ENTER.

Moving Through Autostar's Menus

The Autostar database is organized in levels for quick and easy navigation.

- Press ENTER to go deeper into Autostar's menu levels.
- Press MODE to move back toward the top menu level.
- Press the Scroll keys to move up and down through the options available for each level.
- Press the Arrow keys to enter characters and digits.

The Arrow keys are also used to move the telescope.

Initializing Autostar

This section describes how to initialize Autostar. Perform this procedure the first time you use Autostar or after performing a RESET (see "RESET," page 28).

1. Make sure that the Dec and R.A. locks (**6 and 9, Fig. 1**) are secured as described on page 7.
2. Verify that Autostar is properly connected to your telescope. See "HOW TO ASSEMBLE YOUR TELESCOPE," page 13.

3. Flip the telescope power switch to the ON position.

The Autostar screen is activated and a copyright message displays briefly, followed by a short beep. Then Autostar takes a few moments to start up the system.

4. A message displays that warns not to look at the Sun. At the end of this message, press the key prompted by Autostar to signify that the message has been read and understood.
5. The Getting Started menu displays a scrolling message. Press ENTER (**2, Fig. 2**) to bypass the Help tutorial and continue with initialization.
6. Autostar then requests the current date. Use the Number keys (**5, Fig. 2**) to enter the digits for the date. Use the Right Arrow key (**5, Fig. 3**) to move from one number to the next in the day display, and also to move to the month. Then, use the Scroll keys (**7, Fig. 3**) to cycle through the list of months.

Initialization is a procedure that ensures that Autostar operates correctly. When you first use Autostar, it doesn't yet know where the observation location site is or the time or date of the observation session.

During the procedure, you will enter information, such as the current time and date, and observation location. Autostar uses this information to precisely calculate the location of celestial objects (such as stars and planets) and to move your telescope correctly for various operations.

NOTE:

Autostar requests the Country/State, City, and Telescope Model information only the first time Autostar is activated. If you wish to change this information, use the "Site" and "Telescope Model" options in the Setup menu. See pages 26 and 27 for more information.

When the current month is displayed, use the Right Arrow (**5, Fig. 2**) to move to the year. Use the Number keys to enter all four digits of the current year. Press ENTER when the date has been entered.

7. Autostar then requests the current time. Use the Number keys to enter the time. (Use a "0" for the first digit if less than 10.) Use the Right (or Left) Arrow key to move from one number to the next. Press one of the Arrow keys (**5, Fig. 2**) to scroll to "AM" or "PM." If you select the "blank" choice that follows "AM" and "PM," the clock displays time in a 24-hour (military time) format. Then, press ENTER to start the clock.
8. The next screen requests the status of Daylight Savings Time. Pressing a Scroll key toggles between the YES/NO settings. Select the desired setting by pressing ENTER.

NOTE: Daylight Savings Time may be referred to by a different name in various areas of the world.

NOTE: When multiple choices are available within a menu option, the current option is usually displayed first and highlighted by a right pointing Arrow (>).

9. The next screen asks for the country or state (listed alphabetically) of the observing site. Use the Scroll keys to cycle through the database of countries, states, and provinces. Press ENTER when the correct location displays.
10. The next screen asks for the city (listed alphabetically) closest to the observing site. Use the Scroll keys to cycle through the database of cities. Press ENTER when the correct city appears on screen.
11. System initialization is complete and the screen reads "Setup: Align."

Observe a Star using the Automatic Tracking Feature

In this example, the Autostar Arrow keys are used to find a star, and then Autostar's tracking capability automatically keeps the star centered in your telescope's eyepiece.

1. Make sure that the Dec and R.A. locks (**6 and 9, Fig. 1**) are secured as described above.
2. Verify that Autostar is properly connected to your telescope. See "HOW TO ASSEMBLE YOUR TELESCOPE," page 13.
3. Flip the telescope power switch to the ON position.
The Autostar screen is activated and a copyright message displays briefly, followed by a short beep. Then Autostar takes a few moments to start up the system.
4. A message displays that warns not to look at the Sun. At the end of this message, press the key prompted by Autostar to signify that the message has been read and understood.
5. Press ENTER (**2, Fig. 2**) repeatedly until "Setup: Align" displays.
6. Press the Scroll Down key repeatedly until "Setup: Targets" displays. Press ENTER (**2, Fig. 12**).
7. "Targets: Terrestrial" displays. Press one of the Scroll keys once (**7, Fig. 2**). "Targets: Astronomical" now displays.
8. Use the Arrow keys (**5, Fig. 2**) to locate a bright star in the night sky. Use the viewfinder (**15, Fig. 1**) to help line up on the star. You may choose any unobstructed, bright star for the purposes of this example. Use Autostar's Arrow keys to center the star in the eyepiece. Once the star is centered, press ENTER to select "Astronomical." The telescope's tracking motors then engage. It may take the tracking motors several seconds to begin tracking. When they do, it may be necessary to once again center the star in the eyepiece. The tracking motors will then keep the star you have chosen in the center of the eyepiece.
9. Press and hold the ENTER key for a few seconds and then release to stop tracking. You may repeat the procedure to locate another star or object using the Arrow keys. Then press ENTER to re-engage the tracking motors.

IMPORTANT NOTE:

While performing the automatic tracking procedure, only use the Arrow keys to move the telescope. Once the telescope has been set in the Alt/Az home position, do not loosen the telescope locks (**6 and 9, Fig. 1**), or move the base manually, or alignment will be lost.

Easy (Two-Star) Align

The fastest and easiest way to locate objects with Autostar's GO TO capabilities is to use Easy Align.

Autostar automatically picks two stars from its database for the Easy Align procedure. During this procedure, Autostar slews the telescope to a first alignment star. The user is asked to verify that the telescope is pointed at the chosen star and then prompted to center the star in the eyepiece. The process is repeated with a second star to complete the alignment.

NOTE: Before aligning the telescope, first verify that "INITIALIZING AUTOSTAR," page 17, has been performed. See "MOVING THROUGH AUTOSTAR'S MENUS," page 17, for a description of how Autostar's keys operate.

How to perform the Easy Align Procedure

If you have just applied power to Autostar, perform steps 1 through 5. If you have just performed the initialization procedure, go to step 6.

IMPORTANT NOTE:

The "Telescope: Mount" option of the Setup menu is set to "Alt/Az" as the default alignment by the factory. The example presented in this section assumes that you are performing an alignment procedure for the first time with your telescope and therefore, the "Telescope: Mount" option does not need to be selected. For information on equatorial (Polar) alignment, see "APPENDIX A," page 45.

1. **Sun Warning** - Press the key prompted by Autostar to accept.
2. **Getting Started** - Press ENTER to continue.
3. **Enter Date** - Enter the current date, then press ENTER.
4. **Enter Time** - Enter the current time. Select "AM," "PM," or 24-hour clock (blank). Then press ENTER.
5. **Daylight Savings** - Select "Yes" or "No," then press ENTER.
6. **Alignment Option Screen** - "Setup: Align" displays. Press ENTER.
7. **Select Alignment** - "Align: Easy" displays. Press ENTER.
8. **Set Home Position** - Autostar then prompts you to set the telescope in the Alt/Az Alignment home position (if necessary). To set your telescope in the "Alt/Az" home position (see Fig. 8):
 - Loosen the telescope's Dec lock (6, Fig. 1).
 - Level the tripod head (1, Fig.3). Level the optical tube by lining up 0° on the Dec setting circle (11, Fig. 1) with the Dec pointer (12, Fig. 1).
 - Tighten the Dec lock (6, Fig. 1) to a firm feel only.
 - Unlock the R.A. lock (9, Fig. 1) and turn the telescope horizontally until it points North. See "LOCATING POLARIS," page 46 for more information.
 - Re-lock the R.A. lock (9, Fig. 1). Press ENTER.
9. **Star Alignment** - The Autostar then chooses two stars to align upon. When the telescope slews to the first star for alignment, it may not appear in the field of view in the eyepiece. The alignment star should be easily recognized and be the brightest star in the area of the sky where the telescope is pointing. Use the Arrow keys to move the telescope until the star is visible and centered in the eyepiece. Press ENTER. Repeat procedure for the second alignment star.

When the procedure is performed correctly, "Alignment Successful" displays. If Autostar does not display this message, perform this procedure again.

NOTE: Autostar locates alignment stars based on the date, time, and location entered. The alignment stars may change from night to night. All that is required is for the observer to center the selected stars in the eyepiece when prompted.



Which One's the Alignment Star?

If Autostar has chosen an alignment star with which you are unfamiliar, how can you be sure if the star in your eyepiece is really the alignment star?

The rule of thumb is that an alignment star is usually the brightest star in that area of the sky. When you view an alignment star in an eyepiece, it stands out dramatically from the rest of the stars in that portion of the sky.

If you have an obstruction, such as a tree or a building blocking your view of the alignment star, or if you have any doubts at all about the star that has been chosen, no problem. Just press the Scroll Down key and Autostar will find another star to align upon.

NOTE: The GO TO key also allows you to perform a "spiral search." A spiral search is useful when the telescope slews to an object, but that object is not visible in the eyepiece after the telescope finishes its search. (This sometimes occurs during an alignment procedure.) Press GO TO when the slew is finished and the telescope starts slewing in a spiral pattern at a very slow speed around the search area. Look through the eyepiece and when the object does become visible, press MODE to stop the spiral search. Then use the Arrow keys to center the object.

Go To Saturn

After performing the Easy Align procedure, the motor drive begins operating and the telescope is aligned for a night of viewing. Objects in the eyepiece should maintain their position even though the Earth is rotating beneath the stars.

IMPORTANT NOTE: Once aligned, only use the GO TO or Arrow keys to move the telescope. Do not loosen the telescope locks (**6 and 9, Fig. 1**), or move the base manually, or alignment will be lost.

This exercise demonstrates how to select a celestial object, the planet Saturn, for viewing from Autostar's database.

NOTE: Saturn is not visible the entire year and you may need to choose another object from Autostar's database; however, the procedure, as described below, remains the same.

1. After the telescope is aligned, "Select Item: Object" displays. Press ENTER.
2. "Object: Solar System" displays. Press ENTER.
3. "Solar System: Mercury" displays. Keep pressing the Scroll Down key until "Solar System: Saturn" displays.
4. Press ENTER. "Calculating" displays. Then "Saturn" and a set of coordinates displays. Note that Saturn's (and other planets') coordinates change throughout the year.
5. Press GO TO. "Saturn: Slewing..." displays and the telescope slews until it finds Saturn. You may need to use the Arrow keys to center Saturn precisely in the eyepiece. Autostar then automatically moves the telescope so that it "tracks" Saturn (or whatever other object you may have chosen); i.e., Saturn remains centered in the eyepiece.

Using the Guided Tour

This example demonstrates using "Tonight's Best" Guided Tour.

1. After observing Saturn, press MODE twice so that "Select Item: Object" displays again.
2. Press the Scroll Down key twice. "Select Item: Guided Tour" displays.
3. Press ENTER. "Guided Tour: Tonight's Best" displays. Press ENTER.
NOTE: If you wish to try out other Guided Tours, press the Scroll Down key to scroll through other tour choices. When the tour you wish to select displays, press ENTER.
4. "Tonight's Best: Searching..." displays. After calculating, "Tonight's Best: Jupiter" displays.
NOTE: Different objects may be displayed on a tour list on any given night.
Press ENTER to display information about the object. Press GO TO to move the telescope to the object.
5. Press MODE to return to the Tour list. Press the Scroll keys to scroll through the list. Press ENTER when you find the next object you wish to observe.
6. Press and hold down MODE for two seconds to leave the Guided Tour menu.

BASIC AUTOSTAR OPERATION

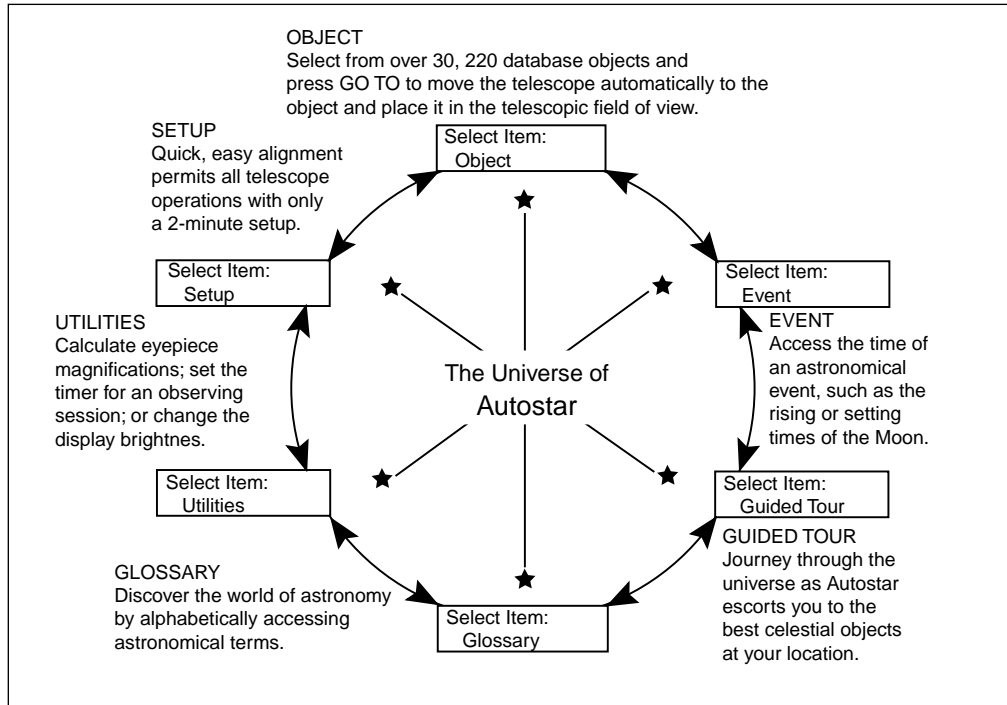

Fig. 9: The Autostar Universe: The six primary categories listed in the Select Item menu of Autostar.

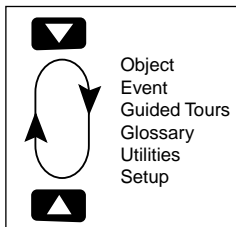

Fig. 10: Menus set in a loop.

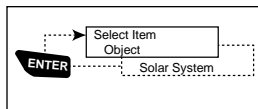

Fig. 11: Autostar levels.

It is important to understand that menu selections are set in a loop (Fig. 9). This means that pressing the Scroll Down key (7, Fig. 2) cycles down through all the available options within a given category, then returns to the first option. The Scroll Up key (7, Fig. 2) cycles up through the options in the opposite order. Note that this capability is a quick way to get to an option that is near the bottom of the list. The following example demonstrates this capability.

Example:

To navigate to the "Select Item: Setup" menu option when the "Select Item: Object" menu is displayed:

1. Press the Scroll Down key four times or the Scroll Up key once.

The screen in Fig. 10 displays two lines of information. The top line shows the current menu level. The second line displays an option which may be selected within that menu level. Some options are choices that select the next menu level down. The Scroll keys move up and down within the list of available options, showing one option at a time.

When the desired option is displayed on the second line, press the ENTER key to choose that option and move down one menu level.

Press the MODE key to leave a level; e.g., the wrong menu option is chosen.

IMPORTANT NOTE: No matter how many levels into Autostar are traveled, each press of the MODE key moves up a level, until the top level, "Select Item," is reached. Once in the Select Item level, press MODE to return to the topmost level, "Select Item: Object."

Autostar Navigation Exercise

To demonstrate how the Autostar menu structure works, the following exercise calculates Sunset time so an evening observing session can be planned.

NOTE: To perform an accurate calculation, Autostar must be properly initialized with the current date, time, and location of the observing site. To enter the current date, time, and location information of your observing site, see "INITIALIZING AUTOSTAR," page 17, before proceeding with this exercise.

To Calculate Sunset time:

1. Press the MODE key several times, until "Select Item: Object" is displayed.
2. Press the Scroll Down key once to display the "Event" option in the "Select Item" menu.
3. Press the ENTER key to choose the "Event" option and move down a level. "Event: Sunrise" is displayed.
4. Press the Scroll Down key once to display the "Sunset" option in the Event menu.
5. Press the ENTER key to choose the "Sunset" option and move down another level.
6. Autostar calculates the Sunset time based on the current date, time, and location. Autostar then displays the results of the calculation.
7. Press MODE once to start moving back up through the Autostar levels. The first level up is the Event menu.
8. Press MODE again to move up another level. This is the top level, "Select Item."
9. Press MODE again to return to the starting point of "Select Item: Object."

Entering data into Autostar

- To enter numbers and text:
 - a) Use the Number keys, if available with your model, or
 - b) Use the Arrow keys to scroll through numbers 0 - 9 and the alphabet. The Down Arrow key begins with the letter "A;" the Up Arrow key begins with digit "9."
- To move the cursor across the display:

Use the Right or Left Arrow key (**5, Fig. 2**) to move the cursor from one number to the next in the display
- Press ENTER when the desired information has been entered.

Navigating Autostar

Autostar's menus are organized for quick and easy navigation:

- Press ENTER to go deeper into Autostar's menu levels.
- Press MODE (**3, Fig. 2**) to move back toward the top menu level.
- Press the Scroll keys to move up and down through the options or lists
- Press the Arrow keys to move the cursor across the display.
- Press the Help (?) key to access on-line help.

***TIP:** When multiple choices are available within a menu option, the option that is currently selected is usually displayed first and highlighted by a right pointing arrow (>).*

MENUS AND MENU OPTIONS

Object Menu

Almost all observing with Autostar is performed using the Object menu category. (**NOTE: Exceptions include Guided Tour and Landmark Survey.**) See "GO TO SATURN," page 20, for an example of observing using the Object menu. Also see "USING THE GUIDED TOUR," page 20.

Many Autostar menu categories contain databases. An Autostar *database* is a list of viewable objects, such as stars, planets, comets, nebulae and so forth. When one of these objects is selected from a database, Autostar moves your telescope (if properly aligned) and points it at the selected object.

The Object Menu options include:

Solar System is a database of the eight planets (Earth is not included) in order out from the Sun, followed by the Moon, asteroids, and comets.

Constellation is a database of all 88 Northern and Southern Hemisphere constellations. When this menu option is chosen and a constellation name appears on the first line of the screen, press GO TO once to change the second line to the name of the brightest star in the constellation. Press GO TO a second time to slew the telescope to that star. Use the Scroll keys to cycle through the list of stars in the constellation, from brightest to dimmest.

Deep Sky is a database of objects outside our Solar System such as nebulae, star clusters, galaxies, and quasars.

Star is a database of stars listed in different categories such as named, double, variable, or nearby.

Satellite is a database of Earth-orbiting objects such as the International Space Station, the Hubble Space Telescope, Global Positioning System (GPS) satellites, and geosynchronous orbit satellites.

User Objects allows the user to define and store in memory deep-sky objects of specific interest that are not currently in the Autostar database. See "Appendix A" for more information.

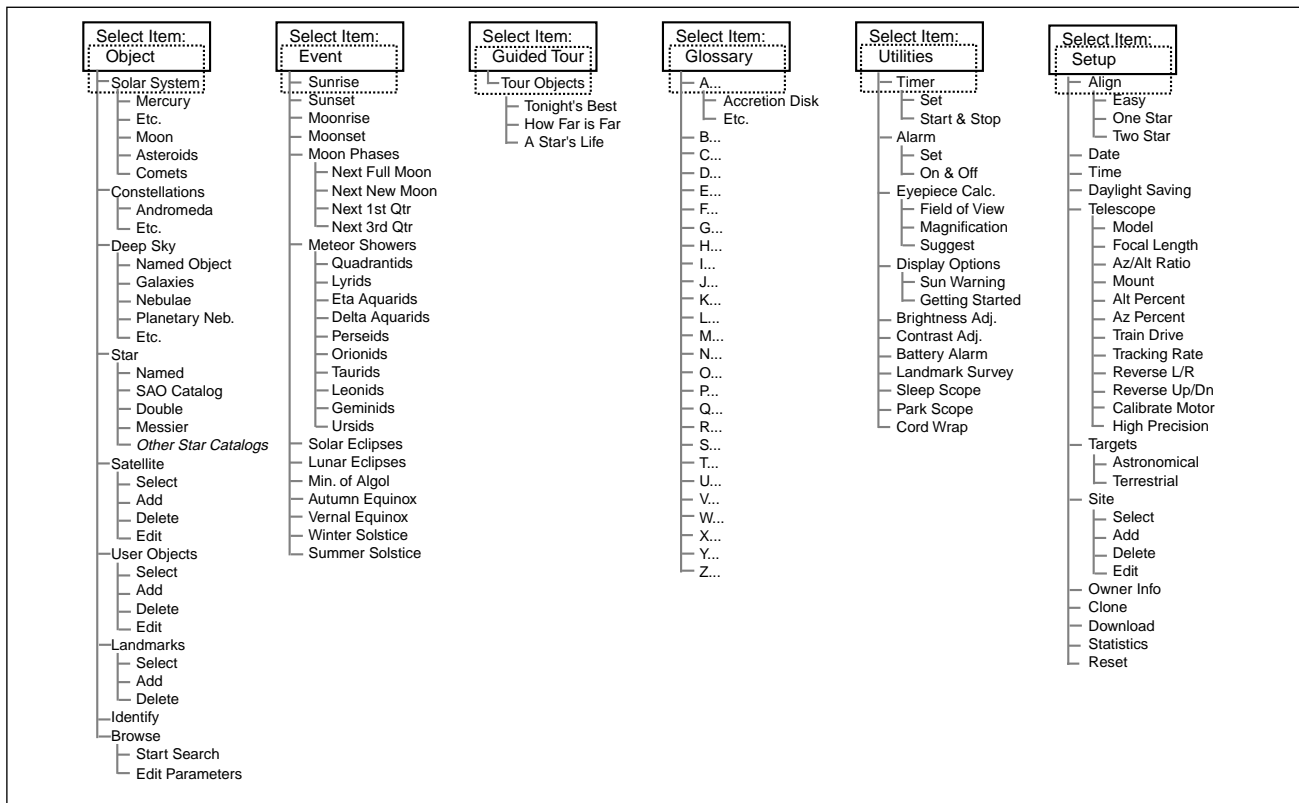

Figure 12: The Complete Autostar Menu Structure.

Landmarks stores the location of terrestrial points of interest in the permanent Autostar database.

IMPORTANT NOTE: To use the Landmark function, the telescope must be located and aligned exactly as when the landmark was added to the database.

- **Select:** To select a Landmark already in the database (see "Add" below), choose the "Select" option and scroll through the list. Press ENTER to select a Landmark, then press GO TO and the telescope slews to the object.
- **Add:** To add a Landmark, choose the "Add" option. Enter a name for the Landmark. Locate and center the Landmark in the eyepiece, then press ENTER.

Identify is an exciting feature for an observer who wants to scan the night sky and start exploring. After the telescope has been properly aligned, use the Autostar Arrow keys to move about in the sky. Then follow this procedure:

IMPORTANT NOTE: Only use the Arrow keys to move the telescope during the Identify procedure. Do not loosen the telescope locks or move the base or alignment is lost.

1. When a desired object is visible in the eyepiece, keep pressing MODE until the "Select Item: Object" menu is displayed. Press ENTER to select this menu.
2. Scroll through the Object menu options until the "Object: Identify" screen appears.
3. Press ENTER. Autostar searches the database for the identity of the object being observed.
4. If the telescope is not directly on an Autostar database object, the nearest database object is located and displayed on the screen. Press GO TO and the telescope slews to that object.

Browse allows you to search the database for objects with certain parameters, much like a search engine. "Edit Parameters" lets you set various parameters for the search, such as: Object Type, Minimum Elevation, Largest, etc. Once you have set the parameters of the search, select "Start Search" and press ENTER. Autostar will display the results of the search. See page 37 for more information.

Event Menu

The Event menu provides access to dates and times of astronomical events. The Event database includes:

Sunrise and **Sunset** calculates the time that the Sun rises or sets on the current date. Find rise and set times for other dates by entering a new date into the "Setup: Date" menu. See "DATE," page 26.

Moonrise and **Moonsset** calculates the time that the Moon rises or sets on the current date. Find rise and set times for other dates by entering a new date into the "Setup: Date" menu. See "DATE," page 26.

Moon Phases displays the date and time of the next Full, New, 1st Quarter, and 3rd Quarter Moon.

Meteor Showers provides information on upcoming meteor showers, such as the Perseids, the Leonids, etc. Also lists the dates of the showers and when they reach maximum.

NOTE: Meteors are fast moving objects that cover large areas of the sky and are usually best observed with the naked eye.

Solar Eclipse lists upcoming Solar Eclipses, including the date and type (total, annular, or partial) of eclipse, and the location and time of the first and last contacts of the Moon's shadow. Use the Scroll Up and Down keys to display the available data. Remember, never use a telescope to look at the Sun! See "WARNING!" to the left.

Lunar Eclipse lists upcoming Lunar Eclipses, including the date and type (total, partial, penumbral) of eclipse. Use the Scroll Up and Down keys to display the available data.

Min. (Minimum) of Algol is the minimum brightness of the dramatic eclipsing binary star system, Algol. It is relatively close at a distance of 100 light years. Every 2.8 days during a 10-hour period, Algol undergoes a major change in apparent magnitude as one of the two stars passes behind the other. The combined magnitude of the two stars thus dips from +2.1 to a minimum of +3.4 halfway through the eclipse as the second star is hidden. Autostar calculates minimum magnitude time at mid-eclipse.



WARNING!
Never use a
Meade®

LX90 Telescope to look at the Sun! Looking at or near the Sun will cause instant and irreversible damage to your eye. Eye damage is often painless, so there is no warning to the observer that damage has occurred until it is too late. Do not point the telescope or its viewfinder at or near the Sun. Do not look through the telescope or its viewfinder as it is moving. Children should always have adult supervision while observing.

Autumn and **Vernal Equinox** calculates the time and date of the fall or spring equinox of the current year.

Winter and **Summer Solstice** calculates the time and date of the winter or summer solstice of the current year.

Glossary Menu

The Glossary menu provides an alphabetical listing of definitions and descriptions for common astronomical terms and Autostar functions. Access directly through the Glossary menu or through hypertext words embedded in Autostar. A *hypertext word* is any word in **[brackets]**, usually found when using the Autostar Help function or when reading a scrolling message such as a description of a planet or star. Press ENTER whenever a hypertext word is on screen and Autostar goes to the glossary entry for that word.

To access directly from the Glossary menu, use the Scroll keys to scroll through the alphabet. Press ENTER on the desired letter. Scroll to the desired entry and then press ENTER to read the description.

Utilities Menu

The Utilities menu provides access to several extra features within Autostar, including a countdown timer and an alarm. The Utilities functions include:

Timer selects a countdown timer. This feature is useful for functions such as astrophotography and tracking satellites. See "OBSERVING SATELLITES," page 31. To use the Timer, press ENTER, then choose "Set" or "Start/Stop."

- **Set:** Enter the time to be counted down, in hours, minutes, and seconds, then press ENTER.
- **Start/Stop:** Activates the timer set previously. Use the Scroll keys to toggle between ON and OFF. When ON is displayed, press ENTER to activate the timer. When the timer runs out, four beeps sound and the timer is deactivated.

Alarm selects a time for an alarm signal as a reminder. To use the Alarm, press ENTER, then choose "Set" or "Start/Stop."

- **Set:** Enter the time of day for the alarm to sound, in hours, minutes, and seconds, then press ENTER.
- **Start/Stop:** Activates the alarm set previously. Use the Scroll keys to toggle between ON and OFF. When ON is displayed, press ENTER to activate the alarm. When the alarm time arrives, Autostar beeps. Press ENTER to deactivate the alarm.

Eyepiece Calc calculates information about an eyepiece for the specific telescope to which Autostar is connected.

- **Field of View:** Scroll through a list of available eyepieces. When an eyepiece is selected, the field of view is calculated.
- **Magnification:** Scroll through a list of available eyepieces. When an eyepiece is selected, the magnification is calculated.

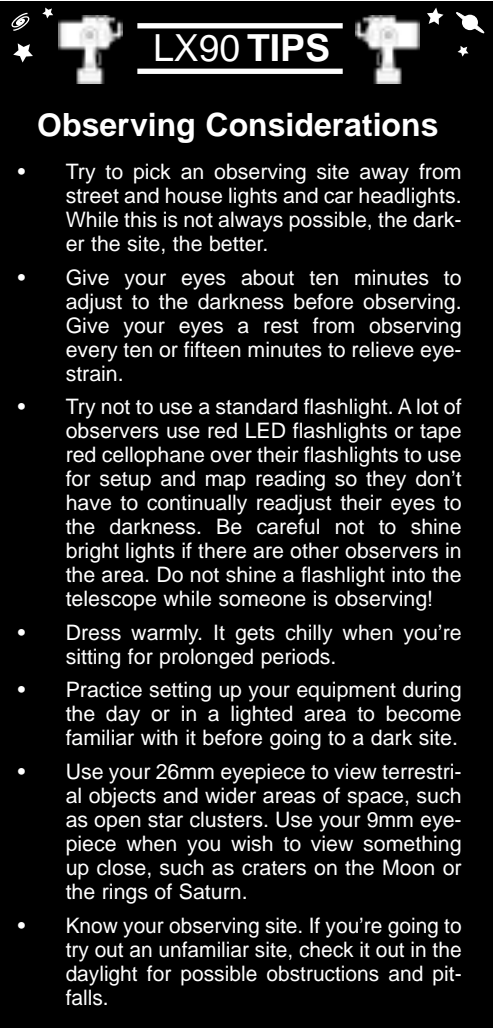

The graphic is a dark rectangular box with a white border. At the top, it features a central title "LX90 TIPS" flanked by two telescope icons and several small star icons. Below the title, the section is titled "Observing Considerations" in a bold, white font. The main content consists of a bulleted list of seven tips for observing, written in white text against the dark background.

LX90 TIPS

Observing Considerations

- Try to pick an observing site away from street and house lights and car headlights. While this is not always possible, the darker the site, the better.
- Give your eyes about ten minutes to adjust to the darkness before observing. Give your eyes a rest from observing every ten or fifteen minutes to relieve eye-strain.
- Try not to use a standard flashlight. A lot of observers use red LED flashlights or tape red cellophane over their flashlights to use for setup and map reading so they don't have to continually readjust their eyes to the darkness. Be careful not to shine bright lights if there are other observers in the area. Do not shine a flashlight into the telescope while someone is observing!
- Dress warmly. It gets chilly when you're sitting for prolonged periods.
- Practice setting up your equipment during the day or in a lighted area to become familiar with it before going to a dark site.
- Use your 26mm eyepiece to view terrestrial objects and wider areas of space, such as open star clusters. Use your 9mm eyepiece when you wish to view something up close, such as craters on the Moon or the rings of Saturn.
- Know your observing site. If you're going to try out an unfamiliar site, check it out in the daylight for possible obstructions and pitfalls.

- **Suggest:** Autostar calculates and suggests the best eyepiece for viewing, based on the telescope and the object being viewed.

Display Options enables or disables Autostar's two initial displays. If both displays are disabled, Autostar begins with the Date display.

- **Sun Warning:** Turns the "Sun Warning" message on or off.
- **Getting Started:** Turns the "Getting Started" message on or off.

Brightness Adj: Adjusts the brightness of the display using the Scroll keys. When complete, press ENTER.

Contrast Adj: Adjusts the contrast of the display using the Scroll keys. When complete, press ENTER.

***NOTE:** This feature is usually only required in very cold weather.*

Landmark Survey automatically slews the telescope to all user-defined landmarks with a short pause at each location. Press ENTER to start the survey. While a slew is in progress, press any key to skip that object and go to the next landmark on the list. To observe a landmark for a longer period, press MODE when paused on the object to stop the survey. Press ENTER to restart the survey at the first object on the list. See "LANDMARKS," page 35.

Sleep Scope is a power saving option that shuts down Autostar and the telescope without forgetting its alignment. With "Sleep Scope" selected, press ENTER to activate the Sleep function. Autostar goes dark, but the internal clock keeps running. Press any key, except ENTER, to re-activate Autostar and the telescope.

Park Scope is designed for a telescope that is not moved between observing sessions. Align the telescope one time, then use this function to park the telescope. Next time it is powered up, enter the correct date and time – no alignment is required. Pressing ENTER causes the telescope to move to its pre-determined Park position. Once parked, the screen prompts to turn off power.

***IMPORTANT NOTE:** When the "Park Scope" option is chosen and the display prompts you to turn off the telescope's power, Autostar is unable to be returned to operation without turning the power off and then back on.*

Cord Wrap, when set to "On," moves the telescope in such a way as to prevent the cords and cables attached to your telescope assembly from getting wound around the assembly and tangled as the telescope slews to objects. "Off" is the default setting.

Setup Menu

The Setup menu's primary function is to align the telescope (see "EASY ALIGN," page 19). However, there are numerous other features available within the Setup menu, including:

Date changes the date used by Autostar. This function is useful to check events in the past or future. For example, set the Date menu for a day three months in the future. Then check the "Select Item: Event" menu for the Sunset time on that date. See "EVENT MENU," page 24.

Time changes the time entered into Autostar. Setting the correct time is critical for Autostar to properly calculate locations and events. Time may be set to 24-hour mode (military time) by selecting the "blank" option which follows the "AM" and "PM" options.

Daylight Saving is used to enable or disable Daylight Savings time.

***NOTE:** Daylight Savings Time may be referred to by different names in various areas of the world. Check local time to verify.*

Telescope accesses the several options, including:

- **Model:** Allows you to select the telescope model connected to Autostar.
- **Focal Length:** Displays the focal length of the selected telescope.
- **Az Ratio and Alt Ratio:** The Az (Azimuth) ratio and Alt (Altitude) ratio refers to the gears of the telescope's motors. Do not alter these numbers.
- **Az Percent:** The Az (Azimuth) Percent allows you to change the azimuth backlash, *i.e.*, the way the Arrow keys move the telescope along the azimuth (horizontal) axis. If you enter a value near 100, the telescope tube responds more quickly (it responds immediately at 100%) as you hold down an Arrow key and also slews (moves) the tube more quickly. If you enter a value near 0, it takes longer for the tube to respond as you hold down an Arrow key and also slews the tube more slowly. Experiment with this option. Try changing the percent value until you get a "feel" for the Arrow keys that is comfortable for you.



Alt Percent: The Alt (Altitude) Percent operates identical to the AZ Percent option (see above), but allows you to change the altitude backlash, *i.e.*, the way the Arrow keys move the telescope when moving along the altitude (vertical) axis.

- **Train Drive:** Trains the Altitude and Azimuth motors to locate objects with more precision. If you are experiencing any problems with pointing accuracy, follow the procedure described in "APPENDIX C: TRAINING THE DRIVE," page 49, to insure accurate pointing and tracking.
- **Tracking Rate:** Changes the speed at which the telescope tracks targets in the sky.
 - a. **Sidereal:** The default setting for Autostar; sidereal rate is the standard rate at which stars move from East to West across the sky due to the rotation of the Earth.
 - b. **Lunar:** Choose this option to properly track the Moon over long observing sessions.
 - c. **Custom:** Allows entry of user-defined tracking rates.
- **Reverse L/R:** Reverses the functions of the Left and Right Arrow keys (*i.e.*, the Right key moves the telescope to the left).
- **Reverse UP/DOWN:** Reverses the functions of the Up and Down Arrow keys (*i.e.*, the Up key moves the telescope down).
- **Calibrate Motor:** If the telescope motors appear to have a problem, use this option to retest the motors before performing a Reset. This option is also used if an Autostar unit is moved between telescopes, to match Autostar to the new telescope. To calibrate the motors, select this option and press ENTER.
- **High Precision:** If High Precision is turned on, when looking for a faint celestial object (*i.e.*, a nebula or galaxy), Autostar first slews to a nearby bright star and displays "ENTER to Sync." Center the star in the eyepiece, then press ENTER. At that point the telescope has a high precision alignment to that part of the sky and it then slews to the object that was originally requested.

Targets switches between Astronomical targets and Terrestrial targets. If "Astronomical" is selected, the telescope tracking motor is activated and any object you observe will remain centered in the eyepiece. If "Terrestrial" is selected, the tracking motor is turned off. To learn how to track an object automatically, see page 18.

Site provides access to several options including:

- **Select:** Displays the currently selected observing site. Use the Scroll keys to cycle through all available sites (see "Add" below). Press ENTER when the site you wish to select displays. Use this option when you move to a different geographic location.
- **Add:** Allows you to add new observing sites to the database (up to six sites may be stored). Scroll through the list of Countries/States. Press ENTER when the site you wish to add displays. Then choose the desired city in the same manner.
- **Delete:** Deletes a stored site from the database.

LX90 TIPS

Surf the Web

One of the most exciting resources for astronomy is the internet. The internet is full of websites with new images, discoveries, and the latest astronomical information. For example, when comet Hale-Bopp made its approach to our Sun in 1998, astronomers around the world posted new photos daily.

You can find websites for almost any topic relating to astronomy on the internet. Try the following key word searches: NASA, Hubble, HST, astronomy, Messier, satellite, nebula, black hole, variable stars, etc.

Check out Meade's website for the latest product and technical information. You can download the latest software revisions, links to other astronomical sites, coordinates of celestial objects and the latest satellite tracking information for your Autostar handset. See page 28 for more information. You'll find our website at:

<http://www.meade.com/>

Here are some other sites you might find interesting:

- *Sky & Telescope:*
<http://www.skypub.com/>
- *Astronomy:*
<http://www2.astronomy.com/astro/>
- *The Starfield:*
<http://users.nac.net/gburke/>
- *Astronomy Picture of the Day:*
<http://antwrp.gsfc.nasa.gov/apod/>
- *Heaven's Above* (satellite observing information):
<http://www.heavens-above.com/>

Time Zone	Shift
Atlantic	-4 Hours
Eastern	-5 Hours
Central	-6 Hours
Mountain	-7 Hours
Pacific	-8 Hours
Hawaii	-10 Hours

Table 1: Time Zone Shift.

- **Edit:** Edits a selected site, including: the name, latitude, longitude, and time zone. Time Zone refers to the Greenwich Mean Time (GMT) time zone shift. Users West of Greenwich, England use “-” hours, East of Greenwich use “+” hours. For the United States, look up the time zone shift in table above.

NOTE: Autostar compensates for daylight savings time, if selected. See “Setup Menu: Daylight Saving,” page 26.

Owner Info accesses the owner information menu, including:

- **Name:** Users may enter both their first and last names using the Up and Down Arrow keys to cycle through the alphabet. Use the Right and Left Arrow keys to move through the text. Press ENTER when the entry is complete.
- **Address:** Use the Up and Down Arrow keys to enter your street address, city, state, and zip code. Press ENTER when the entry is complete.

Download transfers information from a personal computer or another Autostar. During the operation, the warning “Downloading Do Not Turn Off” appears.

NOTE: The Download function requires the optional #505 Astrofinder Software and Cable Connector Kit. See the instruction sheet included with the kit for more information on how to download. Also see “OPTIONAL ACCESSORIES,” page 39.

Clone uploads information from one Autostar handbox to another. Three options are available:

- **Catalogs:** Sends only user-defined object information, such as new satellite orbits or comet data to another Autostar handbox.
- **Software:** Sends only the basic Autostar software. This is useful if one user has downloaded a new version of Autostar software from the Meade website (www.meade.com) and wants to pass this software along to friends.
- **All:** Everything – user-defined information and Autostar software – is sent to another Autostar.

Statistics provides basic statistical data about Autostar, including:

- **Characters Free:** Shows how much room is available in user-defined object memory.
- **Version:** Shows the current version of the Autostar software.

Reset completely resets Autostar. Most values entered into the menus revert to factory defaults. Autostar requires initialization again after a Reset before proceeding with observations. See “INITIALIZING AUTOSTAR,” page 17.

ADVANCED AUTOSTAR FEATURES

Before trying out the examples in this section, familiarize yourself with the basic operations of Autostar described earlier in this manual. The following examples assume that you have a basic knowledge of Autostar and understand how to scroll to a desired menu or menu option, and how to enter numbers and text. It also assumes that you have initialized Autostar and have placed the telescope in the "Home" position (when appropriate).

Adding Observing Sites

If you plan to observe using Autostar at different geographic locations, you can store up to six observation sites in Autostar's memory to help simplify your telescope setup. Perform these procedures using the Site options (Add, Select, Delete, Edit) of the Setup menu.

To Add a Site to the user-defined site list:

In this example, you will choose a city and add it to the database list. You will then select the site to enable it.

1. Navigate to the "Setup: Site" menu. Press ENTER,
2. Scroll through the options until "Site: Add" displays. Press ENTER.
3. Scroll through the list of countries/states. Press ENTER when the country/state you wish to add displays.
4. Scroll through the list of cities. Press ENTER when the city you wish to add displays. The Site is now add to the database. You may add 5 sites using this method (the sixth site is the site you added during the Initialization process)
5. To choose a site, navigate to "Setup: Select." Press ENTER. Scroll through the list of sites. When the desired site displays, press ENTER.

To Edit a Site:

In this procedure, you will enter a location that is not available in the Autostar database by editing data of a nearby site. You will edit the location's name, latitude, longitude and the time zone shift. You will then select the site to enable it.

You will need to know the latitude and longitude of your location to perform this procedure.

1. Using the Add option, choose a site on the list that is closest to your observing site and press ENTER so that the site is added to your observing sites list. Choosing a site already on the list (as opposed to using the "Custom" feature) makes it easier to edit, as the "Time Zone" value may not need to be changed.
2. Scroll to "Site: Edit" and press ENTER. "Edit: Name" displays. Press ENTER.
3. The name of the site you have just entered to your list displays; if it does not, scroll to the site.
4. Using the Arrow keys, change the name of the site so that it now reads the name of your observing location. Press ENTER. "Edit: Name" displays again.



LX90 TIPS

Look into the Future

The Autostar Date option in the Setup menu is much more than just an entry of today's date; with it you can look far into the future or learn about past events. Autostar can calculate the date and times of future events and, except for eclipses, past events as well (based on the current calendar system). *E.g.*, a Sunrise on March 6, 2043 A.D. or the Vernal Equinox in 1776 A.D. To use this feature, enter the desired date in the Setup menu and select an option in the Event menu.

Autostar can calculate dates and times for Sunrises, Sunsets, Moonrises, Moonsets, Moonphases, Solar and Lunar Eclipses (for the next 100 years), meteor showers, equinoxes and solstices, and the minimums of Algol.

One very practical use of the date menu is to check the Sunset option to determine when you can begin your astronomical observing.

Time Zone	Shift
Atlantic	-4 Hours
Eastern	-5 Hours
Central	-6 Hours
Mountain	-7 Hours
Pacific	-8 Hours
Hawaii	-10 Hours

Table 1: Time Zone Shift.

5. Press the Scroll Down key and "Edit: Latitude" displays. Press ENTER.
6. Using the Number Keys, enter the latitude of your observing site and then press ENTER. "Edit: Latitude" displays again.
7. Press the Scroll Down key and "Edit: Longitude" displays. Press ENTER.
8. Using the Number Keys, enter the longitude of your observing site and then press ENTER. "Edit: Longitude" displays again.
9. Press the Scroll Down key and "Edit: Time Zone" displays. Press ENTER. (If the site you chose from the list in step 1 has the same Time Zone as the site you are editing, just press ENTER again to go on to the next step.) "Time Zone" refers to the Greenwich Time Zone shift. Users West of Greenwich, use "-" hours (one hour per time zone) and users East of Greenwich use "+" hours. For the United States, look up the shift in **Table 1**.
10. After entering the shift, press ENTER. "Edit Time Zone" displays.
11. Press MODE. "Site: Edit" displays.
12. Using the Arrow keys, scroll to "Site: Select." The site you have just edited displays. Press ENTER to select the site or press MODE to exit.

TIP:

Entering R.A. and Dec Coordinates of an object without using the menus:

If you do not wish to navigate through the menus, a more direct way to enter coordinates is to press and hold MODE for two seconds or more. R.A. and Dec coordinates display. Press GO TO. "Object Position" and a set of coordinates displays. Enter the R.A. and Dec coordinates of any celestial object using Number keys, overwriting the coordinates currently displayed. As soon as the coordinates are entered, Autostar slews the telescope to the coordinates. Note that the telescope must be initialized (see page 17) and placed in the Home position (see page 17 for this procedure to operate properly.

However, if you wish to store the coordinates of an object in memory, use the method described at the right.

Using Autostar to Find Objects Not in the Database

In this procedure, you will enter coordinates of celestial objects that do not appear in any of the Autostar database lists. You will enter the object's name and RA and Dec coordinates (required information). You may also enter the object's magnitude and size (optional information).

Although Autostar contains an extensive database of celestial objects (stars, nebulae, planets, etc.) that you can observe, you may eventually want to view objects that are not part of the database. Autostar provides a feature that allows you to enter an object's R.A and Dec coordinates in the "User: Objects" option of the Object menu and allows automatic slewing of the telescope to the user-entered coordinates.

In order to use this menu option, you first need to look up the R.A and Dec coordinates of the object or objects you wish to observe. Check out your local library, computer store, or bookstore for astronomy books, CD Roms, or magazines (such as *Sky & Telescope* or *Astronomy*), to find coordinates of celestial objects. The objects/coordinates you enter become part of your own permanent database, called "User Objects."

To enter coordinates of an object into the "User: Objects" option of the Object menu:

1. Make sure Autostar has been initialized and the telescope has been aligned.
2. After the telescope is aligned, "Select Item: Object" displays. (If necessary, use the Scroll keys to scroll through the menus, as previously described, to find this option.) Press ENTER.
3. "Object: Solar System" displays. Keep pressing the Scroll Up key until "Object: User Object" displays and press ENTER.
4. "User Object: Select" displays. Press the Scroll Down key once. "User Object: Add" displays. Press ENTER.
5. "Name" displays on the top line and a blinking cursor on the second line. Use the Arrow keys, as previously described, to enter the name of the object you wish to add to the database. When you are finished, press ENTER.
6. "Right Asc.: 00.00.0" displays. Use the Number keys to enter the digits for the Right Ascension coordinate of your object. When you are finished, press ENTER.
7. "Declination: +00°.00" displays. Use the Number keys to enter the digits for the Declination coordinate of your object. If necessary, use the Scroll Keys to change "+" to "-" When you are finished, press ENTER.
8. Autostar then prompts you to enter the size of the object. This step is optional. Use the Number keys to enter the size (in arc-minutes), if so desired, and press ENTER to go to the next display. If you do not wish to enter this information, simply press ENTER.

9. Autostar then prompts you to enter the magnitude of the object. This step is also optional. Use the Number keys to enter this information, if so desired, and press ENTER to go to the next display. "User Object: Add" displays again.

To GO TO a user-entered object:

In this procedure, you will choose an object from the User Object list and GO TO the object.

1. With "User Object: Add" displayed, press the Scroll Up key once. "User Object: Select" displays. Press ENTER.
2. Use the Scroll keys (if necessary) to scroll to the desired object. Press ENTER.
3. The name of the object and the Right Ascension and Declination coordinates display.
4. Press GO TO and the telescope slews to the object.

Observing Satellites

In this procedure, you will prepare your telescope to observe a satellite pass.

1. Navigate to the "Object: Satellite" menu option and press ENTER.
2. Use the Scroll keys to scroll through the list of satellites.
3. Select a satellite from list and press ENTER.
4. "Calculating...." and then "Tracking..." displays. If the satellite is going to make a pass, "Located" displays.
5. Use the Scroll keys to display data about the pass: aos – acquisition of signal and los – loss of signal. If you subtract the aos from the los, you can calculate how long the satellite will be visible. Location information also displays.
6. "Alarm" displays after the location information. Press ENTER and Autostar automatically sets the alarm to sound a minute before the satellite's scheduled appearance. You may return to regular observations until the alarm goes off.
7. When the alarm goes off, return to the Satellite menu and press a Scroll key until the desired satellite is on the top line of the display.
8. Press GO TO. Autostar slews the telescope to where the satellite should appear. The motor drive stops and a countdown is displayed.

NOTE: *If the scheduled appearance position of the satellite is obstructed (i.e., by a building, tree, or hill), press ENTER and Autostar starts to move the telescope along the expected satellite track. When the track clears the obstruction, press ENTER again to pause the telescope, then continue with this procedure.*

9. With about 20 seconds left on the countdown timer, start watching through the telescope viewfinder for the satellite to enter the field of view.
10. When the satellite enters the viewfinder field of view, press ENTER. The telescope starts to track with the satellite.
11. Use the Autostar Arrow keys to center the object in the viewfinder, then look through the eyepiece to view the object.

Satellite orbits change and new satellites (including the Space Shuttle) are launched. Visit the Meade web site (www.meade.com) approximately once a month to get updated information and instructions on how to download this data to Autostar. If orbital parameters are more than one month old, the satellite pass may not happen at the time predicted by Autostar. Downloading requires the optional #505 AstroFinder™ Software and Cable Connector Kit. See "OPTIONAL ACCESSORIES," page 39.

NOTE: *Satellite observing is an exciting challenge. Most satellites are in low orbit, travelling at approximately 17,500 mph. When visible, they move quickly across the sky and are only in the field of view for a few minutes, requiring Autostar to slew the telescope rapidly. Best viewing is near Sunrise or Sunset when the sky is still dark. Viewing in the middle of the night can be problematic because the satellite may pass overhead, but not be visible as it is in the Earth's shadow.*

How to Create Your Own Guided Tour

When a Guided Tour is selected, Autostar slews your telescope to a predetermined list of objects and displays information about each object, such as type of object, constellation location, R.A. and Dec coordinates, and so forth. Autostar contains a few Guided Tours which are programmed at the factory. But it is also possible for an observer to create a custom Guided Tour.

A tour is basically an ASCII text file that contains a list of directions and descriptions. Each line of a tour is either a comment line, a command line, or a description.

What you will need:

- A PC with text editor or word processing software installed (the tour must be saved as a "text only" or as a "MS-DOS text" file).
- The Meade #505 Cable Connector Kit to download tour information to the Autostar handbox.

Tour Modes

The objects chosen for a tour list are selected from Autostar's database or by entering the object's RA and Dec coordinates. The tour is presented in one of two modes:

Automatic Mode: The title of an object appears on first line and descriptive text scrolls on line 2.

Interactive Mode: Tour name appears on the first line of the Autostar display and the name of the object displays on line 2. To display descriptive text in this mode, the user must press ENTER.

Comment Line

Information in the Tour program that is not displayed, such as authorship, revision history, copyrights, etc. All comments begin with a "/" character in column 1 of the line. For example:

```
/ Extreme Objects
/ (c) 2000 Meade Instruments Corporation
```

Command Line

This line contains programming commands, including: RA and DEC coordinates, a title string, a description string, and a keyword.

RA: Enter the Right Ascension of an object in the following format: HH:MM:SS. *Eg.*, 18:51:05

Dec: Enter the Declination of an object in the following format: DDdMMmSSs. *Eg.*, - 06d16m00s

Title String: Text within a title string is displayed as the title of the object. A title string can contain up to 16 characters and must be surrounded by quotation marks. For example. "M64" or "My Favorite Star."

In Interactive Mode, the title string appears on line 2 until it is selected with the ENTER key.

In Automatic Mode, or after Interactive Mode selection, the title string appears on line 1 while the description scrolls across line 2.

Keywords: Action to be performed during a tour. Autostar recognizes the following keywords:

TITLE	TEXT	USER	NGC
IC	SAO	MESSIER	CALDWELL
PLANET	MOON	SATELLITE	ASTEROID
COMET	LUNAR ECLIPSE	METEOR SHOWER	DEEP SKY
CONSTELLATION	STAR	LANDMARK	DEFINE
PICK ONE/PICK END	AUTO SLEW ON/OFF	#END	

Description String: Description of an object. Must be surrounded by quotation marks. If the description is longer than one line, each line must end with a quotation mark and a hard return. Begin the next description line with a quotation mark.

If quotation marks are to be displayed in the on-screen description, use two quote marks at the beginning and end of the desired phrase. For example: "The Orion Nebula is considered ""awesome"" by many who view it."

Writing a Tour

Using the list of commands listed above, a custom tour can be created. Placing the word AUTO SELECT before any of the command lines activates Automatic Mode and, when selected, Autostar automatically searches and finds the designated object.

The following is a list of command lines, complete with keywords and necessary strings:

TITLE

Title must be the first keyword in your tour after any comment lines and must be 15 characters or less. Autostar displays this title when "Guided Tour" is selected from the menus.

For example: TITLE "A Star's Life"

TEXT "title string" "description string"

This command allows you to display a text title and description.

USER ra dec "title string" "description string"

This command line allows you to access a specific object with your own description. Enter USER, then the RA and DEC of a desired object, and its title and description. Use the format described in the Command Line section.

The following commands specify objects that are already in the Autostar database. If these commands follow the command AUTO SELECT, the object's title displays on line 1 and its description scrolls across line 2.

Do not add a description string after the following command lines; these commands access objects with existing description in the Autostar database.

NGC xxxx

Enter NGC followed by the desired New General Catalog number and Autostar provides the user with a description of the object from its database. For example: NGC 4256

IC xxxx

Enter IC followed by the desired Index Catalog number and Autostar provides the user with a description of the object from its database. For example: IC 1217

SAO xxxxxx

Enter SAO followed by the desired SAO number and Autostar provides the user with a description of the object from its database. For example: SAO 30200

Messier xxx

Enter MESSIER followed by the desired Messier number and Autostar provides the user with a description of the object from its database. For example: M 101

CALDWELL xxx

Enter CALDWELL followed by the Caldwell number and Autostar provides the user with a description of the object from its database. For example: CALDWELL 17

PLANET "name"

Enter PLANET and then the name of the desired planet in quotes. Autostar provides the user with a description of the selected planet from its database. For example: PLANET "Pluto"

MOON

This command accesses information about the Moon from the Autostar database.

SATELLITE "name"

Enter SATELLITE and then the name of the desired satellite in quotes. Autostar displays information about the satellite from its database. For example: SATELLITE: "Intl Space Stn"

ASTEROID "name"

Enter ASTEROID and then the name of the desired asteroid in quotes. Autostar displays information about the asteroid from its database. For example: ASTEROID: "Ceres"

COMET "name"

Enter COMET and then the name of the desired comet in quotes. Autostar displays information about the comet from its database. For example: COMET: "Halley"

LUNAR ECLIPSE

If LUNAR ECLIPSE is part of the tour, Autostar checks its database every time the tour is activated to see if a lunar eclipse is visible that evening. If no eclipse is visible, this option is skipped and the tour proceeds on to the next object.

METEOR SHOWER

If METEOR SHOWER is part of the tour, Autostar checks its database every time the tour is activated to see if a meteor shower is visible that evening. If no meteor shower is visible, this option is skipped and the tour proceeds on to the next object.

DEEP SKY "name"

Enter DEEP SKY followed by the name of the desired object in quotes. For example:
DEEP SKY "Small Magellanic Cloud"

CONSTELLATION "name"

Enter CONSTELLATION followed by the name of the desired constellation in quotes. For example: CONSTELLATION "Leo Major"

STAR "name"

Enter STAR followed by the name of the desired star in quotes. For example: STAR "Vega"

LANDMARK az alt "title" "description"

Enter the azimuth (az) for the desired object in the following format: xxxdxxmxxs. For example: 123d27m00s. Then enter the altitude of the desired object in the following format: xdxmxxs. Then enter the title string and description string in quotes. For example:
LANDMARK 123d27m00s 57d20m20s "Landmark 1" "North corner of apartment building"

PICK ONE / PICK END

These two statements are used to surround a list of items that Autostar can choose from during a tour. Autostar begins at the top of the PICK ONE list and displays the first object from the list that is above the horizon and ignores the rest.

This statement is useful for developing tours that can be presented year round. For each object type you wish to use to illustrate in your tour, pick 10 to 12 examples spaced across the range of right ascension. Bracket them by the PICK ONE / PICK END statements. One current example displays for the user. For example:

```
AUTO SELECT TEXT "Globular Cluster" "Globular clusters are huge balls of stars."
```

```
"They contain 50,000 to 100,000 stars and are located on the fringes of our"
```

```
"galaxy."
```

```
PICK ONE
```

```
AUTO SELECT MESSIER 13
```

```
AUTO SELECT MESSIER 15
```

```
AUTO SELECT MESSIER 92
```

```
AUTO SELECT MESSIER 4
```

```
AUTO SELECT MESSIER 68
```

```
AUTO SELECT NGC 1234
```

```
AUTO SELECT TEXT "None Available" "I'm sorry. There are no bright globular"
```

```
"clusters visible at this time."
```

```
PICK END
```

AUTO SLEW ON / AUTO SLEW OFF

With AUTO SLEW ON enabled in the tour, Autostar automatically slews the telescope to objects first before displaying the text description. This feature is useful when designing tours in which observing certain objects is required. For example, an astronomy professor may require his students to observe six objects, four of which Autostar automatically slews to in a tour. The students would have to manually slew to the last two objects. He would then place AUTO SLEW ON before his first required object and AUTO SLEW OFF after the fourth object.

#END

To end a tour, type the command #END on a separate line at the very end of the tour.

Downloading Tours

Once a tour is written and stored as an ASCII file (saved either as a "text only" or "MS DOS text" file), load it into Autostar using the Autostar Update Utility on your PC. As tours are downloaded into the handbox, Autostar examines the programming. If it doesn't understand the terminology used within a tour, it flags questionable areas and displays them in a pop-up window on your computer screen. Make the necessary corrections and try to download again. See the instruction sheet with your #505 Cable Connector Kit for more information about downloading data to and interfacing with Autostar.

Landmarks

This menu option allows you to define and store terrestrial objects in the Landmark database. First, a landmark needs to be stored in memory using the "Landmark: Add" option. To view a landmark, use the "Landmark: Select" option. Landmarks may also be viewed using the "Landmark Survey" option in the Utilities menu.

To Add a landmark to the database:

In this procedure, you will store the location of terrestrial landmarks in Autostar's memory.

1. Set the telescope in the home position, if necessary. Note for future reference where the telescope is located and if you have aligned the telescope, which alignment method is used.
***IMPORTANT NOTE:** To use the Landmark function, the telescope must be located and aligned exactly as when the landmark(s) was added to the database.*
2. Display the "Setup: Targets" menu option. Chose "Terrestrial" and press ENTER – "Setup: Targets" displays again. Choosing this option turns off tracking for astronomical objects and is not useful for the viewing of terrestrial objects such as those in the Landmark database. Be sure to change this option back to "Astronomical" when you wish to view celestial objects again.
3. Press MODE once. "Select Item: Setup" displays.
4. Press the Scroll Down key once and "Select Item: Object" displays. Press ENTER. "Object: Solar System" displays.
5. Press the Scroll Up key twice and "Object: Landmarks" displays. Press ENTER. "Landmark: Select" displays.
6. Press the Scroll Down key once. "Landmark: Add" displays. Press ENTER.
7. "Landmark Name" displays. Using Arrow keys, enter a name for the landmark you wish to add to the database. When finished, press ENTER.
8. "Center Landmark. Press Enter" displays. Using only the Arrow keys (do not manually move the telescope), move the telescope to the desired landmark and center the object in the eyepiece. Press ENTER. The object is now stored in memory.
9. "Landmark: Add" displays. If you wish to add more landmarks, repeat steps 5 through 7.

To Select a landmark from the database:

1. Make sure the telescope is located and aligned exactly as when the desired landmark was entered into memory.
2. Display the "Landmark: Select" menu option. Press ENTER.
3. Use the Scroll keys to scroll through the list of objects you have previously entered. When the desired object displays, press ENTER to select the object. Use the Scroll keys to scroll through location information about the object, if desired. Press GO TO to slew the telescope to the landmark.
4. Press MODE to exit.

To perform a Landmark Survey

This procedure allows you to perform a tour of the objects entered in the "Object: Landmark" menu option – note that the Landmark Survey will function only if you have previously entered objects in the Landmark menu.

1. Navigate to "Utilities: Landmark Survey" menu and press ENTER.
2. "Landmark Survey: Slewing..." displays. The telescope moves to the first object on the Survey list and displays the name of the object.
3. Press MODE to pause the Survey. Press ENTER to restart the survey at the first object of the survey.

To check on the available amount of memory in Autostar.

Autostar has a limited amount of memory. Once you begin to store Landmarks, User Objects and other bits of information in Autostar, you will begin to use up memory. This procedure allows you to check on how much memory is still available.

1. Navigate to the "Setup: Statistics" menu option and press ENTER.
2. "Statistics: 37.2K Char. Free" displays. This is the amount of memory that is still available to the user.

Identify

This procedure allows you to use Autostar to identify objects you have found in the night sky using the Arrow keys. If the object is not in Autostar's database, Autostar displays information about an object in its database that is closest to the one you queried about.

IMPORTANT NOTE: For this function to operate properly, you must first set the telescope in the home position and initialize Autostar. If you physically move the telescope after initialization, this function will fail to operate properly.

In this procedure, you will center an object you wish to have identified by Autostar in the telescope eyepiece and use the "Identify" menu to find out information about the object or the nearest object to it in the Autostar database.

1. Center the object you wish to have identified in the telescope's eyepiece.
2. Navigate to the "Object: Identify" option and press ENTER.
3. "Searching..." displays. When Autostar finishes calculating, the name of the closest object displays.
4. Press a Scroll key to display information about this object. Autostar displays some or all the following information about the object with each press of a Scroll key:

Displayed information:

Catalog or common name of object
Type of object
Right Ascension
Declination
Constellation
Magnitude
Size
Scrolling message

Example:

Messier 107, NGC6171, Orion Nebula, etc
Globular Cluster, Nebula, Black Hole, etc.
16:32:4
13°03'
Virgo, Orion, etc.
3
2'
"This Globular Cluster is 10,000 light years away...."

Advanced Alt/Az Alignment

If you would rather choose your own alignment stars from the Autostar database during the Alt/Az alignment procedure, Autostar offers two methods. Information for Equatorial (Polar) alignment is discussed in "Appendix A," page 45.

Two-Star Alt/Az Alignment

Two-Star Alignment requires some knowledge of the night sky. Autostar provides a database of bright stars and two stars from this database are chosen by the observer for alignment.

1. **Perform steps 1 through 7** as described in "EASY ALIGN," page 19.
2. With "Align: Easy" displayed, use the Scroll keys to display "Align: Two Star." Press ENTER.
3. Place the telescope in the home position as described in the "EASY ALIGN" procedure. When you have finished, press ENTER.
4. "Select Star" displays. Autostar then displays a database of stars for the observer to choose from. Use the Scroll keys to scroll to a star on the list that you wish to align upon. Select a star that you can easily locate in the night sky. Press ENTER.
5. The telescope slews to the star. Use the Arrow keys to move the telescope until the star is centered in the eyepiece. Press ENTER.
6. Repeat procedure for the second alignment star. The telescope is aligned and you are now ready to use Autostar's GO TO capabilities for a night of observing.

One-Star Alt/Az Alignment

One-Star Alignment requires some knowledge of the night sky. Autostar provides a database of bright stars. One-Star Alignment is identical to Two-Star Alt/Az: Alignment (see "TWO-STAR ALT/AZ ALIGNMENT," above), except only one star from this database is chosen by the observer for alignment.

IMPORTANT NOTE: *The accuracy of One-Star Alt/Az Alignment, unlike the Two-Star and Easy (Alt/Az) Alignment procedures, depends on how well the observer levels the telescope and how close to North the telescope is pointed when setting the Home Position (Fig. 8). Because the other methods use two stars to align upon, they are more precise than One-Star Alignment.*

Browse

This menu allows you to search the database for objects with certain parameters, much like a search engine. "Edit Parameters" lets you set various parameters for the search, and "Start Search" activates the search. A typical search might be performed as follows:

1. Select "Browse" from the Object menu. Press ENTER. "Browse: Start Search" displays.
2. Press one of the Scroll Keys and "Browse: Edit Parameters" displays. Press ENTER.
3. "Edit Parameters: Largest (mins)" displays. "Mins" stands for arc-minutes. Press ENTER.
4. "Largest (mins)" and a value displays. Using the Number keys, enter a size in arc-minutes. Autostar will search for objects *up to* this size and no larger. Press ENTER.
5. "Edit Parameters: Largest (mins)" displays again. Press the Scroll Down key. "Edit Parameters: Smallest (mins)" displays. Enter the value for the smallest size of an object that Autostar will search for in the database. Continue with "Brightest," "Faintest," and "Minimum Elevation," using the procedure described in steps 3 and 4.
6. After "Minimum Elevation," "Object Type" displays. Press ENTER. "+Black Hole" displays. If you do *not* wish to have "Black Holes" in your search, press ENTER and the "+" changes to a "-." Press the Scroll Down to scroll to the next item. "+Diffuse Nebula" displays. Continue to scroll through the list and press ENTER if you wish to change the "+" to a "-" or vice-versa.
7. After you have scrolled to the last item on the "Object Type" list, press MODE twice and the Scroll Down key once. "Browse: Start Search" displays. Press ENTER. "Start Search: Next" displays. Press ENTER. Autostar searches the database and displays the first object that matches the search parameters you have entered. Use the scroll keys to display information about the object. Press MODE and "Start Search: Next" displays again. Press ENTER and the next item matching the parameters displays. Repeat this procedure to display all the objects.
8. Press MODE repeatedly to leave this menu.

PHOTOGRAPHY WITH THE LX90

Photography through the LX90 requires the addition of the optional #62 T-Adapter. See "OPTIONAL ACCESSORIES," page 39. With the #62 T-Adapter and a T-mount attached to the telescope (Fig. 13), through-the-telescope photography is possible with any 35mm camera body with a removable lens. In this way, the telescope effectively becomes the lens of the camera.

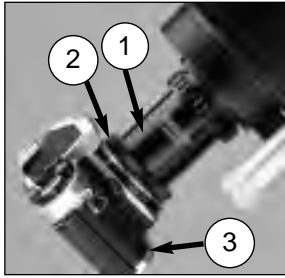

Fig. 13: LX90 with #62 T-Adapter.

The #62 T-Adapter (1, Fig. 13) threads on to the photo port, followed by a T-Mount (2, Fig. 13) for the particular brand of 35mm camera being used, followed by the camera body (3, Fig. 13).

To orient an object in the viewfinder of the 35mm camera body, use a small jeweler's screwdriver to slightly loosen three adjustment screws around the outer knurled ring of the T-Mount. Rotate the camera body to achieve proper orientation of the object; then re-tighten the adjustment screws.

The #62 T-Adapter permits close-coupling of a camera body to the telescope. In this format vignetting occurs: the photographic image appears on film with a slight darkening (vignetting) at the corners of the 35mm frame (Fig. 14).

Photography through a long lens such as the LX90 requires special technique for good results, and the photographer should probably expect to waste a roll or two of film in acquiring this technique. Long-lens photography has its own rewards, however, rewards that short-focus lenses cannot duplicate.

A few tips on photography with the LX90:

1. Use the Field Tripod for the telescope. At an effective focal length of 2000mm, even small external vibrations can easily ruin an otherwise good photo.

CAUTION: With the #62 T-Adapter and a camera body mounted to the LX90 photo port, the telescope can only be rotated vertically about 45°. Moving past this point may damage the telescope and camera.

2. Use a cable-operated shutter release. Touching the camera body to initiate shutter operation almost certainly introduces undesirable vibrations.
3. Focus the image with extreme care. While observing the subject through the camera's reflex viewfinder, turn the telescope's focus knob (8, Fig. 1) to achieve the sharpest possible focus. Note that some 35mm cameras may have an optional focusing screen (available from the manufacturer) for use with a long telephoto lens. This screen provides a brighter and clearer image to focus, and is highly recommended.
4. Correct shutter speeds vary widely, depending on lighting conditions and film used. Trial-and-error is the best way to determine proper shutter speed in any given application.

NOTE: The camera used with your telescope may have an exposure meter that is still active when the standard lens is removed and the body is connected to the telescope with the T-Mount. If used for terrestrial photography, the camera meter should be acceptable. If used for astrophotography, the meter probably will not provide good results since camera meters are not made to compensate for a dark sky.

5. Terrestrial photography through the LX90 is sensitive to heat waves rising from the Earth's surface. Long distance photography is best accomplished in the early morning hours before the earth has had time to build up heat.
6. Photography of the Moon and planets through the LX90 can be especially gratifying, but points 1 through 4 should be particularly noted in this case. Lunar or planetary photography requires that the telescope be Polar aligned. See "APPENDIX A," page 45.



Fig. 14: Example of vignetting.

OPTIONAL ACCESSORIES

A wide assortment of professional Meade accessories is available for the LX90 telescope. The premium quality of these accessories is well-suited to the quality of the instrument itself. **Consult the Meade General Catalog for complete details on these and other accessories.**

Meade Series 4000 Eyepieces:*

Eyepiece	Magnifying Power	With #140 2x Barlow Lens
Super Plössl (4-elements)		
SP 6.4mm	313X	626X
SP 9.7mm	206X	412X
SP 12.4mm	161X	322X
SP 15mm	133X	266X
SP 20mm	100X	200X
SP 26mm	77X	154X
SP 32mm	63X	126X
SP 40mm	50X	100X
SP 56mm	36X	72X
Super Wide Angle (6-elements)		
SWA 13.8 mm	145X	290X
SWA 18mm	111X	222X
SWA 24.5mm	82X	164X
SWA 32mm	63X	126X
SWA 40mm	50X	100X
Ultra Wide Angle (8-elements)		
UWA 4.7mm	426X	852X
UWA 6.7mm	299X	598X
UWA 8.8mm	227X	454X
UWA 14mm	143X	286X



Fig. 15: Series 4000 Eyepieces.



Fig. 16: #909 Accessory Port Module (APM).



Fig. 17: #928 45° Erect-Image Diagonal Prism.



Fig. 18: Illuminated Reticle Eyepiece.

* Refer to "CHOOSING AN EYEPIECE," page 14, and "TOO MUCH POWER," page 15, to determine which optional eyepieces are best-suited to your applications and how to avoid "overpowering" the telescope.

#140 2x Barlow Lens: An amplifying lens, the #140 2x Barlow doubles the power of all eyepieces with which it is used. Insert the #140 into the telescope's eyepiece-holder first, followed by the diagonal prism and eyepiece.

#909 Accessory Port Module (APM): The #909 APM attaches to the rear cell of the LX90 and connects by cable to the Aux port on the telescope's control panel. The APM includes auxiliary connectors for plug-in of such accessories as corded models of illuminated reticle eyepieces, the #1206 Electric Focuser, or a CCD autoguider.

#505 AstroFinder™ Software and Cable Connector Kit: With Meade AstroFinder loaded into your PC, Autostar-equipped telescopes, such as the LX90, may be remotely controlled from the PC display. The #505 Connector Cable Set, permitting connection of the LX90, Autostar, and PC, is included with each AstroFinder package.

#928 45° Erect-Image Diagonal Prism: Primarily used for terrestrial viewing, this prism presents a correctly-oriented image at a comfortable 45° viewing angle.

Illuminated Reticle Eyepieces: Meade Illuminated Reticle Eyepieces are used for precise polar alignment of your telescope. During long-exposure astrophotography, in conjunction with the optional Meade Off-Axis Guider, they are used for through-the-telescope monitoring of the object being photographed while the camera's shutter is open. Two optical designs are available: Series 4000 Plössl 9mm or Modified Achromatic 12mm. Each model is available in a wireless or corded configuration. The wireless models include a variable brightness control with self-contained (user-provided) batteries. The corded models include variable brightness and blink rate functions and plug directly into the Accessory Port Module (see above), with actuation from the hand controller.



Fig. 19: #62 T-Adapter.



Fig. 20: Off-Axis Guider.

#62 T-Adapter: The T-Adapter is the basic means of prime-focus photography through all Meade Schmidt-Cassegrain models. Thread the T-Adapter on to the rear cell of your telescope, followed by a T-Mount for your 35mm camera, and the camera body is rigidly coupled to the telescope.

Variable Tele-Extender: For eyepiece-projection photography of the Moon and the planets, a Tele-Extender is required. The variable Tele-Extender threads onto the telescope's eyepiece-holder, into which is inserted an eyepiece of typically about 26mm focal length; the 35mm camera body couples to the tele-extender by means of a T-Mount. The Meade Variable Tele-Extender permits a range of projection images.

Off-Axis Guider: The Off-Axis Guider provides a means during long-exposure astrophotography for the photographer to monitor the tracking of the telescope to assure that the telescope remains precisely positioned on the object being photographed. Like the T-Adapter, the Off-Axis Guider couples the camera body to the telescope but it also causes a small amount of the guidestar's incoming light to be diverted at a right angle, where the star's position can be examined for tracking errors with an illuminated reticle eyepiece; position corrections can then be effected using Autostar.

Electric Focusers: Meade electric focusers are uniquely designed to yield smooth, precise microfocusing of the image, without disabling the manual focus knob, which may be used for rapid coarse focusing. Two focuser models are available: the #1205, which includes pushbutton hand controller with self-contained (user-provided) battery, and the #1206, which plugs directly into the Accessory Port Module (see previous page), with actuation from the hand controller.

Piggyback Brackets: Piggyback photography is one of the most popular and easiest ways to get started in astrophotography. Attach your 35mm camera, with its own 35mm-to-250mm lens, atop your LX90 in equatorial mode, and guiding the camera through the main telescope, wide-field photos of the Milky Way of remarkable detail and clarity can be taken.

Dew Shield: In moist climates, water particles suspended in the atmosphere may condense on the front surface of the telescope's correcting plate. This dew formation may be inhibited to a significant extent by the addition of a dew shield, essentially an extension tube attaching to the front-cell of the telescope.

#541 AC Adapter: The optional #541 AC Adapter permits powering of the telescope via a standard household (115v.AC) electrical outlet.

#607 Power Cord: Powering the LX90 telescope by means of an automobile cigarette lighter plug requires the #607 Power Cord. With this 25 ft. cord, the LX90 may be powered for a full night's observing without risk of car-battery drain.

MAINTENANCE

The LX90 is a precision optical instrument designed to yield a lifetime of rewarding applications. Given the care and respect due any precision instrument, the LX90 will rarely, if ever, require factory servicing. Maintenance guidelines include:

- a. Avoid cleaning the telescope's optics: a little dust on the front surface of the telescope's correcting lens causes virtually no degradation of image quality and should not be considered reason to clean the lens.
- b. When absolutely necessary, dust on the front lens should be removed with gentle strokes of a camel hair brush or blown off with an ear syringe (available at any pharmacy). DO NOT use a commercial photographic lens cleaner.
- c. Organic materials (e.g., fingerprints) on the front lens may be removed with a solution of 3 parts distilled water to 1 part isopropyl alcohol. You may also add 1 drop of biodegradable dishwashing soap per pint of solution. Use soft, white facial tissues and make short, gentle strokes. Change tissues often.

CAUTION: Do not use scented or lotioned tissues or damage could result to the optics.

- d. **Do not, for any reason, remove the correcting plate from its machined housing for cleaning or other purposes. You will almost certainly not be able to replace the corrector in its proper rotational orientation and serious degradation of optical performance will result. Meade Instruments assumes no liability for damage incurred to the telescope in this way.**
- e. If the LX90 is used outdoors on a humid night, water condensation on the telescope surfaces will probably result. While such condensation does not normally cause any damage to the telescope, it is recommended that the entire telescope be wiped down with a dry cloth before the telescope is packed away. Do not, however, wipe any of the optical surfaces. Rather, simply allow the telescope to sit for some time in the warm indoor air, so that the wet optical surfaces can dry unattended.
- f. If the LX90 is not to be used for an extended period, perhaps for one month or more, it is advisable to remove the batteries from the telescope. Batteries left in the telescope for prolonged periods may leak, causing damage to the telescope's electronic circuitry.
- g. Do not leave the LX90 inside a sealed car on a warm summer day; excessive ambient temperatures can damage the telescope's internal lubrication and electronic circuitry.

Collimation

The optical collimation (alignment) of any astronomical telescope used for serious purposes is important, but in the case of the Schmidt-Cassegrain design of the 8" LX90, such collimation is absolutely essential for good performance. Take special care to read and understand this section well so that your LX90 will give you the best optical performance.

As part of final optical testing, every Meade Schmidt-Cassegrain is precisely collimated at the Meade factory before shipment. However, vibrations in shipping can cause the optical system to become misaligned. Re-aligning the optics is, however, a straightforward process.

To check the collimation of your LX90, center a bright star that is overhead, or use a "hot spot" of reflected Sunlight from a chrome car bumper, with the supplied 26mm eyepiece. Allow the telescope to adjust to the temperature of your observation site before proceeding; temperature differences between the optics and the outside air can cause distortion in the images.

With the star or hot spot centered, de-focus the image. You will notice that the out of focus star image looks like a ring of light surrounding a dark central spot; the dark central spot is in fact the shadow of the secondary mirror. Turn the focus knob until the

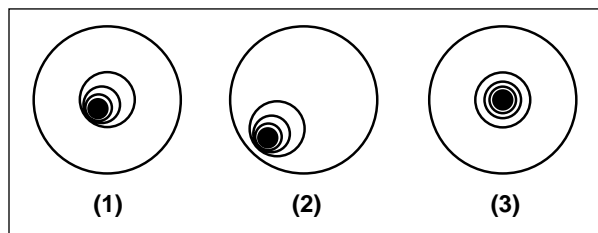

Fig. 21: Defocused star images.

ring of light fills about 10% of the eyepiece field-diameter. If the dark central spot is offset in (i.e., not concentric with) the ring of light, your telescope's optical system is misaligned and requires collimation.

Follow these steps for collimation of the optical system:

- a. The only adjustments possible, or necessary, on the LX90 are from the three screws (**Fig. 21**) located at the edge of the outer surface of the secondary mirror housing.

CAUTION: Do not force the three collimation screws past their normal travel and do not loosen them more than two full turns in a counterclockwise direction or the secondary mirror may come loose from its support. You will find that the adjustments are very sensitive, usually requiring only one-half turn or less to produce the desired result.

- b. While looking at the defocused star image, notice which direction the darker shadow is offset in the ring of light or notice which part of the ring is the thinnest (**1, Fig. 21**). Place your index finger in front of the telescope so that it touches one of the collimation set screws. You will see the shadow of your finger in the ring of light. Move your finger around the edge of the black plastic secondary mirror support until you see the shadow of the finger crossing the thinnest part of the ring of light. At this point, look at the front of the telescope where your finger is aiming. It will either be pointing directly at a set screw, or it will be between two set screws aiming at the set screw on the far side of the black plastic secondary mirror support. This is the set screw that you will adjust.
- c. Using the Arrow keys at the slowest slew speed, move the defocused image to the edge of the eyepiece field of view (**2, Fig. 21**), in the same direction as the darker shadow is offset in the ring of light.
- d. Turn the set screw that you found with the pointing exercise while looking in the eyepiece. You will notice that the star image will move across the field. If while turning the defocused star image flies out of the eyepiece field, then you are turning the screw the wrong way. Turn the opposite direction and bring the image back to the center of the field.
- e. If the screw you are turning becomes very loose, tighten the other two screws by even amounts. If the screw you are turning gets too tight, unthread the other two by even amounts.
- f. When you bring the image to center (**3, Fig. 21**), carefully examine the evenness of the ring of light (concentricity). If you find that the dark center is still off in the same direction, continue to make the adjustment in the original turning direction. If it is now off in the opposite direction, you have turned too far and you need to turn in the opposite direction. Always double check the image in the center of the field of the eyepiece.
- g. You may find after your initial adjustment that the dark center is off in a new direction (e.g., instead of being off side-to-side it is now off in an up-and-down direction). In this case repeat steps b through f to find the new adjustment screw.
- h. Now try a higher power eyepiece (e.g., 9mm or less) and repeat the above tests. Any lack of collimation at this point will require only very slight adjustments of the three set screws. You now have good collimation of the optics.
- i. As a final check on alignment, examine the star image in focus with the higher power eyepiece as suggested above, under good viewing conditions. The star point should appear as a small central dot (commonly referred to as an "Airy disc") with a diffraction ring surrounding it. To give a final precision collimation, make extremely slight adjustments of the three set screws, if necessary, to center the Airy disc in the diffraction ring. You now have the best alignment of the optics possible with this telescope.

Inspecting the Optics

A Note About the "Flashlight Test:" If a flashlight or other high-intensity light source is pointed down the main telescope tube, the view (depending upon the observer's line of sight and the angle of the light) may reveal what appears to be scratches, dark or bright spots, or just generally uneven coatings, giving the appearance of poor quality optics. These effects are only seen when a high intensity light is transmitted through lenses or reflected off the mirrors, and can be seen on any high quality optical system, including giant research telescopes.

The optical quality of a telescope cannot be judged by the "flashlight test;" the true test of optical quality can only be conducted through careful star testing.

Gauging the Movement of the Telescope

A common complaint of many first-time telescope owners is that they cannot see the telescope "move" when the motor drive is engaged. In fact, when the batteries are installed, the power is on and the R.A. lock engaged, the telescope is moving. However, the movement is at the same speed as the hour hand of a 24-hour clock; as such, the movement is difficult to discern visually.

To check the movement of your telescope, look at an astronomical object through the telescope's eyepiece with the telescope polar aligned and with the motor drive on. If the object remains stationary in the field of view, your telescope is operating properly. If not, check to ensure that you have engaged the R.A. lock and that the power switch on the control panel is on. Also check if "Astronomical" is selected in the "Targets" option of the setup menu.



Fig. 22: R.A. Lock.



Fig. 23: Dec Lock.

Meade Customer Service

If you have a question concerning your LX90, contact the Meade Instruments Customer Service Department at:

Telephone: (949) 451-1450

Fax: (949) 451-1460

Customer Service hours are 8:30 AM to 4:30 PM, Pacific Time, Monday through Friday. In the unlikely event that the LX90 requires factory servicing or repairs, write or call the Meade Customer Service Department first, before returning the telescope to the factory, giving full particulars as to the nature of the problem, as well as your name, address, and daytime telephone number. The great majority of servicing issues can be resolved by telephone, avoiding return of the telescope to the factory.

LX90 Specifications

Optical design	Schmidt-Cassegrain
Clear aperture	8"
Focal length	2000mm
Focal ratio (photographic speed)	f/10
Resolving power.....	0.56 arc secs
Coatings	Meade EMC Super Multi-Coatings
Mounting	Cast-aluminum, double-tine forks
Gears	4.9"-dia worm gears, both axes
Alignment	Altazimuth or equatorial w/optional wedge
Pointing Precision	5 arc-minutes in GO TO mode
Slew Speeds	1x sidereal to 6.5°/sec in 9 increments
Tripod	Variable-height field tripod
Accessories	8 x 50mm finder 1.25" diagonal prism Super Plössl 26mm eyepiece
Net telescope weight	31 lbs.
Net tripod weight	20 lbs.

Autostar Specifications

Processor	68HC11, 8MHz
Flash Memory	1MB, reloadable
Keypad	20 key alphanumeric
Display	2 line, 16 character LCD
Backlight.....	Red LED
Utility Light	Yes
RS-232	Yes
Coil Cord	24"
Database	30,223 objects

Autostar Dimensions

Length	6.56" (16.6cm)
Width (LCD end)	3.19" (80cm)
Width (Connector end).....	2.25" (57cm)
Depth	0.81" (21cm)
Autostar net weight	1.12 lbs (0.51kg)

APPENDIX A: EQUATORIAL (POLAR) ALIGNMENT

Polar Alignment



Fig. 24: Tripod set in Polar configuration with an optional wedge.

In Polar Alignment, the telescope is oriented so that the horizontal and vertical axes of the telescope are lined up with the celestial coordinate system.

In order to Polar align your telescope, it is essential to have an understanding of how and where to locate celestial objects as they move across the sky. This section provides a basic introduction to the terminology of Polar-aligned astronomy, and includes instructions for finding the celestial pole and for finding objects in the night sky using Declination and Right Ascension.

Celestial Coordinates

Celestial objects are mapped according to a coordinate system on the Celestial Sphere (**Fig. 25**), an imaginary sphere surrounding Earth on which all stars appear to be placed. This celestial object mapping system is analogous to the Earth-based coordinate system of latitude and longitude.

The poles of the celestial coordinate system are defined as those two points where the Earth's rotational axis, if extended to infinity, North and South, intersect the celestial sphere. Thus, the North Celestial Pole (**1, Fig. 25**) is that point in the sky where an extension of the Earth's axis through the North Pole intersects the celestial sphere. This point in the sky is located near the North Star, Polaris.

In mapping the surface of the Earth, lines of longitude are drawn between the North and South Poles. Similarly, lines of latitude are drawn in an East-West direction, parallel to the Earth's Equator. The Celestial Equator (**2, Fig. 25**) is a projection of the Earth's Equator onto the celestial sphere.

Just as on the surface of the Earth, in mapping the celestial sphere, imaginary lines have been drawn to form a coordinate grid. Thus, object positions on the Earth's surface are specified by their latitude and longitude. For example, you could locate Los Angeles, California, by its latitude (+34°) and longitude (118° West); similarly, you could locate the constellation Ursa Major (which includes the Big Dipper) by its general position on the celestial sphere:

R.A.: 11hr; Dec: +50°.

- **Right Ascension:** The celestial analog to Earth longitude is called "Right Ascension," or "R.A.," and is measured in time on the 24 hour "clock" and shown in hours or "hr," minutes or "min," and seconds or "sec," from an arbitrarily defined "zero" line of Right Ascension passing through the constellation Pegasus. Right Ascension coordinates range from 0hr 0min 0sec to 23hr 59min 59sec. Thus there are 24 primary lines of R.A., located at 15 degree intervals along the celestial equator. Objects located further and further East of the prime Right Ascension grid line, 0hr 0min 0sec, carry increasing R.A. coordinates.
- **Declination:** The celestial analog to Earth latitude is called Declination, or "Dec," and is measured in degrees, arc-minutes and arc-seconds, e.g., 15° 27' 33". Declination shown as North of the celestial equator is indicated with a "+" sign in front of the measurement, e.g., the Declination of the North Celestial Pole is +90°, with Declination South of the celestial equator indicated with a "-" sign, e.g., the Declination of the South Celestial Pole is -90°. Any point on the celestial equator itself which, for example, passes through the constellations Orion, Virgo, and Aquarius, is specified as having a Declination of zero, shown as 0° 0' 0".

All celestial objects are specified in position by their celestial coordinates of Right Ascension and Declination.

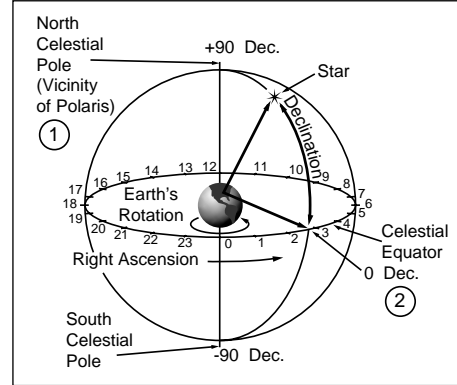

Fig. 25: Celestial Sphere.

Using setting circles requires a developed technique. When using the circles for the first time, try hopping from one bright star (the calibration star) to another bright star of known coordinates. Practice moving the telescope from one easy-to-find object to another. In this way, the precision required for accurate object location becomes evident.

NOTE: You may also enter an object's R.A. and Dec coordinates using the "User: Objects" option of Autostar's Object menu. Autostar then automatically slews the telescope to the entered coordinates.

Locating the Celestial Pole

To get basic bearings at an observing location, take note of where the Sun rises (East) and sets (West) each day. After the site is dark, face North by pointing your left shoulder toward where the Sun set. To precisely point at the pole, find the North Star (Polaris) by using the Big Dipper as a guide (**Fig. 25**).

For precise tracking of astronomical objects, your telescope should be Polar aligned.

IMPORTANT NOTE: For almost all astronomical observing requirements, approximate settings of the telescope's latitude and Polar axis are acceptable. Do not allow undue attention to precise Polar Alignment of the telescope to interfere with your basic enjoyment of the instrument.

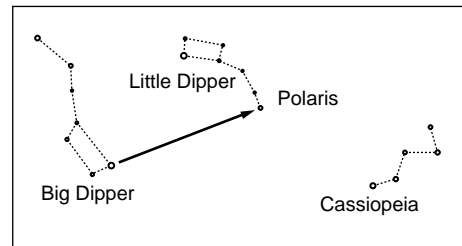

Fig. 26: Locating Polaris.

Autostar Polar Alignment

Autostar provides three different methods for Polar Alignment: Easy, One-Star and Two-Star. In each method, the telescope is pointed at Polaris, which Autostar uses the star as a reference.

Easy Polar Alignment

Polaris and two alignment stars are chosen by Autostar based on the date, time, and location entered. First, choose "Polar" from the "Setup: Telescope" menu. The rest of the procedure is identical to the (Alt/Az) "EASY ALIGN," page 19, except that Autostar prompts you to point the telescope at Polaris and center it in the telescope eyepiece.

One-Star Polar Alignment

Polar Two-Star Alignment requires some knowledge of the night sky. Autostar provides a database of bright stars and one star from this database is chosen by the observer for alignment. Polaris is chosen by Autostar. First, choose "Polar" from the "Setup: Telescope" menu. The rest of the procedure is almost identical to the (Alt/Az) "ONE STAR ALT/AZ ALIGNMENT," page 37, except that Autostar you to point the telescope at Polaris and center it in the telescope eyepiece.

Two-Star Polar Alignment

Polar Two-Star Alignment requires some knowledge of the night sky. Autostar provides a database of bright stars and two stars from this database are chosen by the observer for alignment. Polaris is chosen by Autostar. The rest of the procedure is almost identical to the (Alt/Az) "TWO STAR ALT/AZ ALIGNMENT," page 37, except that Autostar prompts you to point the telescope at Polaris and center it in the telescope eyepiece.

Setting Circles

Setting circles included with the LX90 permit the location of faint celestial objects not easily found by direct visual observation. R.A. circle is located on the top surface of the telescope's drive base. Declination circles (**8**, **Fig. 1**) are located at the top of each fork tine. With the telescope pointed at the North Celestial Pole, the Dec circle should read 90° (understood to mean +90°). Objects located below the 0-0 line of the Dec circle carry minus Declination coordinates. Each division of the Dec circle represents a 1° increment. The R.A. circle runs from 0^h to (but not including) 24^h, and reads in increments of 5^{min}.

IMPORTANT NOTE: In order to select any of Autostar's three Polar Alignment options, you must first select "Polar" in the "Mount" option of the "Setup: Telescope" menu.

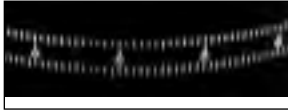

Figure 27: Section of Right Ascension Setting Circle.



Figure 28: Section of Declination Setting Circle.



Fig. 29: Equatorial Wedge.



Fig. 30: LX90 mounted on an equatorial wedge.

Note that the R.A. circle is double-indexed (i.e., there are two series of numbers running in opposite directions around the circumference of the R.A. circle). The upper series of numbers (increasing counterclockwise) applies to observers located in the Earth's Northern Hemisphere; the lower series of numbers (increasing clockwise) applies to observers located in the Earth's Southern Hemisphere.

To use the setting circles to locate an object not easily found by direct visual observation:

With the telescope aligned to the Celestial Pole, first look up the celestial coordinates (R.A. and Dec.) of the object in a star atlas. Then loosen the R.A. lock and turn the telescope to read the correct R.A. of the desired object; lock the R.A. lock onto the object. Next, turn the telescope in Declination to read the correct Declination of the object. If the procedure has been followed carefully, and if the telescope was well-aligned with the pole, the desired object should now be in the telescopic field of a low-power eyepiece.

If you do not immediately see the object you are seeking, try searching the adjacent sky area. Keep in mind that, with the 26mm eyepiece, the field of view of the LX90 is about 0.5°. Because of its much wider field, the viewfinder may be of significant assistance in locating and centering objects, after the setting circles have been used to locate the approximate position of the object.

Pinpoint application of the setting circles requires that the telescope be precisely aligned with the pole. See "LOCATING THE CELESTIAL POLE," page 46.

EQUATORIAL WEDGE

An optional equatorial wedge allows a more precise Polar alignment. Polar alignment allows you to take longer exposure photographs with your LX90.

The LX90 requires an adapter to attach the equatorial wedge to the tripod. See the instruction sheet supplied with the wedge for installation.

Equatorial Wedge

The equatorial wedge permits use in an astronomical, or "equatorial," mode. The wedge fits onto the field tripod.

NOTE: The Meade equatorial wedge is designed solely for use in conjunction with the Meade field tripod. The wedge should never be used without the field tripod (e.g., by placing the wedge alone on a table top and then mounting the telescope on the wedge – the wedge may become seriously imbalanced, to the point where the telescope may actually tip over.

Included features:

- Attachment of the wedge to the field tripod by means of only one manual knob.
- Quick azimuth adjustment by loosening the manual knob as described above.
- Bubble level for rapid tripod/wedge leveling.
- Etched latitude scale for fast adjustment of the latitude angle.

APPENDIX B: HELPFUL CHARTS

Latitude Chart for Major Cities of the World

To aid in the Polar Alignment procedure (see page 45), latitudes of major cities around the world are listed below. To determine the latitude of an observing site not listed on the chart, locate the city closest to your site. Then follow the procedure below:

Northern Hemisphere observers (N): If the site is over 70 miles (110 km) North of the listed city, add one degree for every 70 miles. If the site is over 70 miles South of the listed city, subtract one degree per 70 miles.

Southern Hemisphere observers (S): If the site is over 70 miles North of the listed city, subtract one degree for every 70 miles. If the site is over 70 miles South of the listed city, add one degree per 70 miles.

UNITED STATES			SOUTH AMERICA		
City	State	Latitude	City	Country	Latitude
Albuquerque	New Mexico	35° N	Asuncion	Paraguay	25° S
Anchorage	Alaska	61° N	Brasilia	Brazil	24° S
Atlanta	Georgia	34° N	Buenos Aires	Argentina	35° S
Boston	Massachusetts	42° N	Montevideo	Uruguay	35° S
Chicago	Illinois	42° N	Santiago	Chile	34° S
Cleveland	Ohio	41° N	<hr/>		
Dallas	Texas	33° N	ASIA		
Denver	Colorado	40° N	City	Country	Latitude
Detroit	Michigan	42° N	Beijing	China	40° N
Honolulu	Hawaii	21° N	Seoul	South Korea	37° N
Jackson	Mississippi	32° N	Taipei	Taiwan	25° N
Kansas City	Missouri	39° N	Tokyo	Japan	36° N
Las Vegas	Nevada	36° N	Victoria	Hong Kong	23° N
Little Rock	Arkansas	35° N	<hr/>		
Los Angeles	California	34° N	AFRICA		
Miami	Florida	26° N	City	Country	Latitude
Milwaukee	Wisconsin	46° N	Cairo	Egypt	30° N
Nashville	Tennessee	36° N	Cape Town	South Africa	34° S
New Orleans	Louisiana	30° N	Rabat	Morocco	34° N
New York	New York	41° N	Tunis	Tunisia	37° N
Oklahoma City	Oklahoma	35° N	Windhoek	Namibia	23° S
Philadelphia	Pennsylvania	40° N	<hr/>		
Phoenix	Arizona	33° N	AUSTRALIA		
Portland	Oregon	46° N	City	State	Latitude
Richmond	Virginia	37° N	Adelaide	South Australia	35° S
Salt Lake City	Utah	41° N	Brisbane	Queensland	27° S
San Antonio	Texas	29° N	Canberra	New South Wales	35° S
San Diego	California	33° N	Alice Springs	Northern Territory	24° S
San Francisco	California	38° N	Hobart	Tasmania	43° S
Seattle	Washington	47° N	Perth	Western Australia	32° S
Washington	District of Columbia	39° N	Sydney	New South Wales	34° S
Wichita	Kansas	38° N	Melbourne	Victoria	38° S
<hr/>			<hr/>		
EUROPE					
City	Country	Latitude			
Amsterdam	Netherlands	52° N			
Athens	Greece	38° N			
Bern	Switzerland	47° N			
Copenhagen	Denmark	56° N			
Dublin	Ireland	53° N			
Frankfurt	Germany	50° N			
Glasgow	Scotland	56° N			
Helsinki	Finland	60° N			
Lisbon	Portugal	39° N			
London	England	51° N			
Madrid	Spain	40° N			
Oslo	Norway	60° N			
Paris	France	49° N			
Rome	Italy	42° N			
Stockholm	Sweden	59° N			
Vienna	Austria	48° N			
Warsaw	Poland	52° N			

APPENDIX C: TRAINING THE DRIVE

Train the telescope motors using Autostar. Perform this procedure if you are experiencing any pointing accuracy problems. **Fig. 31** depicts the complete Drive Training procedure.

NOTE: Use a terrestrial object, such as a telephone pole or lamp post, to train the drive. Complete this exercise once every 3 to 6 months to maintain the highest level of telescope pointing accuracy.

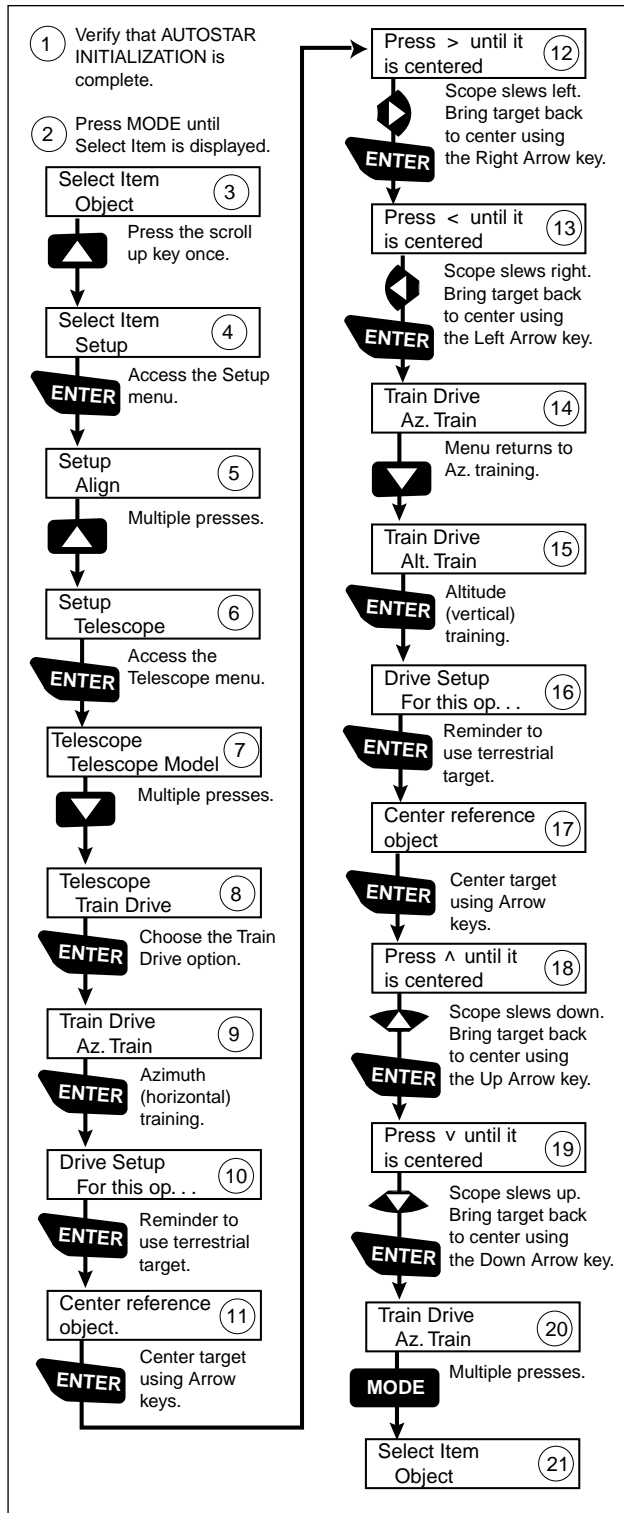

Figure 31: Training the Drive Procedure.

Further Study...

This manual gives only the briefest introduction to astronomy. If you are interested in pursuing further studies in astronomy, a few topics are suggested below that are worth reading up on. Try looking up some of these topics in Autostar's glossary.

Also included below is a small sampling of books, magazines, and organizations that you might find helpful.

Topics

1. How is a star born? How does a solar system form?
2. How is the distance to a star measured? What is a light year?
3. What is red shift and blue shift?
4. How are the craters on our Moon formed? How old are the Moon and Earth? How old is the Sun?
5. What is a black hole? A quasar? A neutron star?
6. What are stars made of? Why are stars different colors? What is a white dwarf? A red giant?
7. What is a nova? A supernova?
8. What are comets? Asteroids? Meteors? Meteor showers? Where do they come from?
9. What is a planetary nebula? A globular cluster?
10. What is the Big Bang? Is the universe expanding or contracting, or does it always remain the same?

Books

1. [The Guide to Amateur Astronomy](#) by Jack Newton and Philip Teece
2. [The Sky: A User's Guide](#) by David Levy
3. [Turn Left at Orion](#) by Guy Consolmagno & Dan Davis
4. [Astrophotography for the Amateur](#) by Michael Covington

Magazines

1. *Sky & Telescope*
Box 9111, Belmont, MA 02178
2. *Astronomy*
Box 1612, Waukesha, WI 53187

Organizations:

1. Astronomical League
Executive Secretary
5675 Real del Norte, Las Cruces, NM 88012
2. The Astronomical Society of the Pacific
390 Ashton Ave, San Francisco, CA 94112
3. The Planetary Society
65 North Catalina Ave, Pasadena, CA 91106

BASIC ASTRONOMY

In the early 17th century Italian Scientist Galileo, using a crude telescope considerably smaller than the LX90, turned it to look towards the sky instead of distant trees and mountains. What he saw, and what he realized about what he saw, forever changed the way mankind thought of the universe. Imagine what it must have been like being the first human to see moons revolve around the planet Jupiter or to see the changing phases of Venus! Because of his observations, Galileo correctly realized Earth's movement and position around the Sun, and in doing so, gave birth to modern astronomy. Yet Galileo's telescope was so crude, he could not clearly make out the rings of Saturn.

Galileo's discoveries laid the foundation for understanding the motion and nature of the planets, stars, and galaxies. Building on his foundation, Henrietta Leavitt determined how to measure the distance to stars; Edwin Hubble proposed a glimpse into the origin of the universe; Albert Einstein unraveled the relationship of time and light. Almost daily, using sophisticated successors to Galileo's crude telescope, such as the Hubble Space Telescope, more and more mysteries of the universe are being solved and understood. We are living in a golden age of astronomy.

Unlike other sciences, astronomy welcomes contributions from amateurs. Much of the knowledge we have on subjects such as comets, meteor showers, variable stars, the Moon, and our solar system comes from observations made by amateur astronomers. So as you look through your Meade LX90 telescope, keep in mind Galileo. To him, a telescope was not a mere machine of glass and metal, but something far more - a window through which the beating heart of the universe might be glimpsed, a fuse to set fire to mind and imagination.

Autostar Glossary

Be sure to make use of Autostar's Glossary feature. The Glossary menu provides an alphabetical listing of definitions and descriptions of common astronomical terms. Access directly through the Glossary menu or through hypertext words embedded in Autostar. See "GLOSSARY MENU," page 25, for more information.

Objects in Space

Listed below are some of the many astronomical objects that can be seen with the LX90:

The Moon

The Moon is, on average, a distance of 239,000 miles (380,000km) from Earth and is best observed during its crescent or half phase when Sunlight strikes the Moon's surface at an angle. It casts shadows and adds a sense of depth to the view (**Fig. 32**). No shadows are seen during a full Moon, causing the overly bright Moon to appear flat and rather uninteresting through the telescope. Be sure to use a neutral Moon filter when observing the Moon. Not only does it protect your eyes from the bright glare of the Moon, but it also helps enhance contrast, providing a more dramatic image.

Using the LX90, brilliant detail can be observed on the Moon, including hundreds of lunar craters and maria, described below.

Craters are round meteor impact sites covering most of the Moon's surface. With no atmosphere on the Moon, no weather conditions exist, so the only erosive force is meteor strikes. Under these conditions, lunar craters can last for millions of years.

Maria (plural for mare) are smooth, dark areas scattered across the lunar surface. These dark areas are large ancient impact basins that were filled with lava from the interior of the Moon by the depth and force of a meteor or comet impact.

Twelve Apollo astronauts left their bootprints on the Moon in the late 1960's and early 1970's. However, no telescope on Earth is able to see these footprints or any other artifacts. In fact, the smallest lunar features that may be seen with the largest telescope on Earth are about one-half mile across.



*Fig. 32: The Moon.
Note the deep shadows in the craters.*

Planets

Planets change positions in the sky as they orbit around the Sun. To locate the planets on a given day or month, consult a monthly astronomy magazine, such as *Sky and Telescope* or *Astronomy*. You can also consult Autostar for information about planets. Scroll to the "Object: Solar System" menu and scroll through the lists of planets. When a planet you are interested in displays, press ENTER. Use the Scroll keys to display information about the planet, such as the planet's coordinates, and the rise and set times (**Tip:** enter a date in the Date menu and you can determine if a planet(s) will be visible during the night of the entered date by checking its rise and set times). Listed below are the best planets for viewing through the LX90.



Fig. 33: Jupiter and its four largest moons. The moons can be observed in a different position every night.

Venus is about nine-tenths the diameter of Earth. As Venus orbits the Sun, observers can see it go through phases (crescent, half, and full) much like those of the Moon. The disk of Venus appears white as sunlight is reflected off the thick cloud cover that completely obscures any surface detail.

Mars is about half the diameter of Earth, and appears through the telescope as a tiny reddish-orange disk. It may be possible to see a hint of white at one of the planet's Polar ice caps. Approximately every two years, when Mars is closest to Earth in its orbit, additional detail and coloring on the planet's surface may be visible.



Fig. 34: Saturn has the most extensive ring structure in our Solar System.

Jupiter is the largest planet in our solar system and is 11 times the diameter of Earth. The planet appears as a disk with dark lines stretching across the surface. These lines are cloud bands in the atmosphere. Four of Jupiter's 16 moons (Io, Europa, Ganymede, and Callisto) can be seen as "star-like" points of light when using even the lowest magnification (**Fig. 33**). These moons orbit Jupiter so that the number of moons visible on any given night changes as they circle around the giant planet.

Saturn is nine times the diameter of Earth and appears as a small, round disk with rings extending out from either side (**Fig. 34**). In 1610, Galileo, the first person to observe Saturn through a telescope, did not understand that what he was seeing were rings. Instead, he believed that Saturn had "ears." Saturn's rings are composed of billions of ice particles ranging in size from a speck of dust to the size of a house. The major division in Saturn's rings, called the Cassini Division, is occasionally visible through the LX90. Titan, the largest of Saturn's 18 moons can also be seen as a bright, star-like object near the planet.



Fig. 35: The Pleiades is one of the most beautiful open clusters.

Deep-Sky Objects

Star charts can be used to locate constellations, individual stars and deep-sky objects. Examples of various deep-sky objects are given below:

Stars are large gaseous objects that are self-illuminated by nuclear fusion in their core. Because of their vast distances from our solar system, all stars appear as pinpoints of light, irrespective of the size of the telescope used.

Nebulae are vast interstellar clouds of gas and dust where stars are formed. Most impressive of these is the Great Nebula in Orion (M42), a diffuse nebula that appears as a faint wispy gray cloud. M42 is 1600 light years from Earth.

Open Clusters are loose groupings of young stars, all recently formed from the same diffuse nebula. The Pleiades is an open cluster 410 light years away (**Fig. 35**). Through the LX90, numerous stars are visible.

Constellations are large, imaginary patterns of stars believed by ancient civilizations to be the celestial equivalent of objects, animals, people, or gods. These patterns are too large to be seen through a telescope. To learn the constellations, start with an easy grouping of stars, such as the Big Dipper in Ursa Major. Then, use a star chart to explore across the sky.

Galaxies are large assemblies of stars, nebulae, and star clusters that are bound by gravity. The most common shape is spiral (such as our own Milky Way), but galaxies can also be elliptical, or even irregular blobs. The Andromeda Galaxy (M31) is the closest spiral-type galaxy to our own. This galaxy appears fuzzy and cigar-shaped. It is 2.2 million light years away in the constellation Andromeda, located between the large "W" of Cassiopeia and the great square of Pegasus.

A Roadmap to the Stars

The night sky is filled with wonder and intrigue. You too, can enjoy exploring the universe simply by following a few pointers on a roadmap to the stars.

First, find the Big Dipper which is part of the constellation Ursa Major. The Big Dipper is usually easy to locate year round in North America.

Extending directly out from the far side of the Big Dipper's cup is the constellation Orion. One of the most exquisite areas of the winter sky, Orion is distinguished by Orion's belt, which is marked by three stars in a row. The Orion Nebula is located South of the belt and is one of the most observed deep-sky objects by amateur astronomers.

Extending from the "pointer stars" of the Big Dipper's cup is Polaris, the North Star. Extending from Polaris is the Great Square shared by the constellations Pegasus and Andromeda.

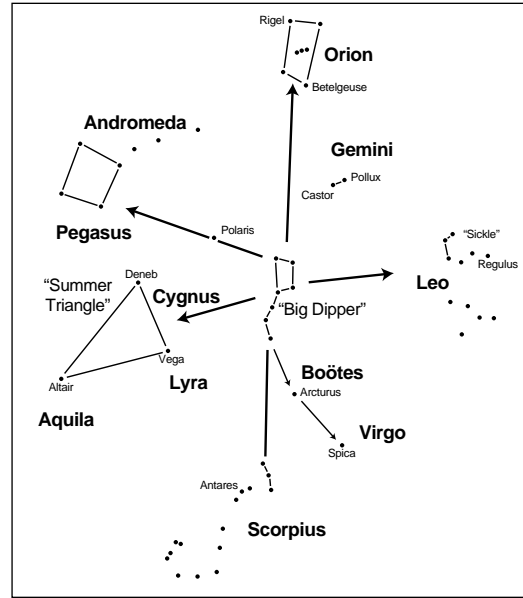

Fig. 36: Road Map to the Stars.

The Summer Triangle is a notable region in the sky to the left of the handle of the Big Dipper. The triangle is made up of three very bright stars: Vega, Deneb, and Altair.

By drawing an imaginary line outward from the handle of the Big Dipper, you reach the southern constellation "Scorpius." Scorpius curves to the left like the tail of a scorpion in the sky, or like letter "J."

Amateur astronomers commonly use the phrase "arc to Arcturus and spike to Spica" to refer to the area directly off the arc in the handle of the Big Dipper. Follow the arc to Arcturus, the second brightest star in the Northern Hemisphere, then spike down to Spica, the 16th brightest star in the sky.

Star Locator

The chart below lists bright stars with their R.A. and Dec coordinates, along with the Northern Hemisphere season when these stars are prominent in the night sky. This list aids the observer to find alignment stars at various times of the year. For example, if it is a midsummer evening in the Northern Hemisphere, Deneb in the constellation Cygnus, would be an excellent alignment star, while Betelgeuse could not be used because it is in the winter constellation Orion and thus, below the horizon.

Season	Star Name	Constellation	R.A.	Dec
Spring	Arcturus	Bootes	14h16m	19° 11"
Spring	Regulus	Leo	10h09m	11° 58"
Spring	Spica	Virgo	13h25m	-11° 10"
Summer	Vega	Lyra	18h37m	38° 47"
Summer	Deneb	Cygnus	20h41m	45° 17"
Summer	Altair	Aquila	19h51m	08° 52"
Summer	Antares	Scorpius	16h30m	-26° 26"
Fall	Markab	Pegasus	23h05m	15° 12"
Fall	Fomalhaut	Pisces Austrinus	s22h58m	-29° 38"
Fall	Mira	Cetus	02h19m	-02° 58"
Winter	Rigel	Orion	05h15m	-08° 12"
Winter	Betelgeuse	Orion	05h55m	07° 25"
Winter	Sirius	Canis Major	06h45m	-16° 43"
Winter	Aldebaran	Taurus	04h35m	16° 31"



MEADE LIMITED WARRANTY

Every Meade telescope, spotting scope, and telescope accessory is warranted by Meade Instruments Corporation ("Meade") to be free of defects in materials and workmanship for a period of ONE YEAR from the date of original purchase in the U.S.A. and Canada. Meade will repair or replace a product, or part thereof, found by Meade to be defective, provided the defective part is returned to Meade, freight-prepaid, with proof of purchase. This warranty applies to the original purchaser only and is non-transferable. Meade products purchased outside North America are not included in this warranty, but are covered under separate warranties issued by Meade international distributors.

RGA Number Required: Prior to the return of any product or part, a Return Goods Authorization (RGA) number **must** be obtained from Meade by writing, or calling (949) 451-1450. Each returned part or product must include a written statement detailing the nature of the claimed defect, as well as the owner's name, address, and phone number.

This warranty is not valid in cases where the product has been abused or mishandled, where unauthorized repairs have been attempted or performed, or where depreciation of the product is due to normal wear-and-tear. Meade specifically disclaims special, indirect, or consequential damages or lost profit which may result from a breach of this warranty. Any implied warranties which cannot be disclaimed are hereby limited to a term of one year from the date of original retail purchase.

This warranty gives you specific rights. You may have other rights which vary from state to state.

Meade reserves the right to change product specifications or to discontinue products without notice.



ADVANCED PRODUCTS DIVISION

Meade Instruments Corporation

World's Leading Manufacturer of Astronomical Telescopes for the Serious Amateur
6001 Oak Canyon, Irvine, California 92618 ■ (949) 451-1450

FAX: (949) 451-1460 ■ www.meade.com

© 2000

14-0670-00 10/00